

# Welcome

---

Thank you for choosing your Motorola TDMA digital StarTAC™ phone from a global leader in communications technology. All Motorola digital cellular phones are designed and manufactured to meet Motorola's rigorous specifications and world-class quality standards. During development, our laboratory testing team took your TDMA digital StarTAC™ cellular phone through rigorous durability tests including temperature, humidity, shock, dust, vibration, and drop tests—and the phone still worked!

We are confident that the phone you purchased will meet your own exacting standards. Enjoy your Motorola TDMA digital StarTAC™ phone.

# Contents

---

<b>Welcome</b> .....	1
<b>Safety Information</b> .....	6
<b>Overview</b> .....	11
Package Content Options .....	11
Phone Overview .....	12
Phone Diagram .....	13
Understanding the Guide .....	14
<b>Using the Battery</b> .....	15
About Your Batteries .....	15
Removing and Attaching Battery Covers .....	16
Installing and Removing Batteries .....	18
Checking Battery Levels .....	19
Charging Batteries .....	20
<b>Using the Phone</b> .....	23
Turning the Phone On and Off .....	23
Reading the Indicators .....	24
Standby Mode .....	27
Storing Your Phone in Its Holster .....	27
Using the Smart Button .....	27
Placing a Call .....	28
Ending a Call .....	29
Receiving a Call .....	29
Switching Between Digital and Analog Modes .....	30
Redialing a Number Automatically .....	30
Controlling Volume .....	31
<b>Using Phone Memory</b> .....	33
Using Your Phone's Built-in Phone Book .....	34
Storing Names and Numbers .....	34
Recalling an Entry by Name .....	38
Recalling an Entry by Memory Location .....	38
Clearing a Phone Memory Entry .....	39
Shortcuts for Recalling Phone Book Entries .....	39
Making Notes on the Scratchpad .....	40

<b>Using the Menu System</b> .....	41
Introducing the Menu Features .....	41
Navigating the Menu .....	42
Road Maps .....	42
<b>Managing Recent Calls</b> .....	43
Road Map for Recent Calls .....	44
About Recent Calls .....	44
Reviewing Received Calls .....	46
Reviewing Dialed Calls .....	47
Clearing Caller Line ID .....	48
<b>Managing the Phone Book</b> .....	49
Road Map for Phone Book .....	50
Recalling an Entry by Name .....	51
Recalling an Entry by Location .....	51
Storing with the Menu .....	52
Storing and Placing Numbers with Pause Dialing .....	53
Storing and Placing Numbers for Calling Card Information .....	55
Attaching an Email Address .....	57
Editing a Memory Location .....	58
Editing an Email Address .....	60
Assigning an Individual Ring Style to a Phone Book Entry .....	61
<b>Setting the Time and Date</b> .....	62
Road Map for Time and Date .....	63
Setting the Time .....	64
Setting the Date .....	65
Changing the Date Format .....	65
Changing the Time Format .....	66
Turning Autoupdate On and Off .....	66
<b>Timing Your Calls</b> .....	67
Road Map for Call Timers .....	68
Viewing Call Timers .....	69
Displaying the Individual Timer Automatically .....	71
Setting the One-Minute Audible Timer .....	71
Setting the Repeating Audible Timer .....	72
Setting the Single Timer .....	73

<b>Adjusting Tone Controls</b> .....	74
Road Map for Tone Controls .....	75
Selecting Call Alert Type .....	76
Selecting Message Alert Type .....	77
Selecting a Ring Style .....	78
Turning Keypad Tones On and Off .....	78
Turning Scratchpad Tones On and Off .....	79
<b>Using Lock/Security Features</b> .....	80
Road Map for Lock Security .....	81
Activating Voice Privacy .....	82
Locking/Unlocking Your Phone .....	83
Activating Priority Calling .....	84
Viewing the Lock Code .....	85
Changing the Lock Code .....	85
Restricting Call Placement .....	86
Resetting All Options .....	88
Clearing All Stored Information .....	89
A-Key Entry .....	89
<b>Customizing Phone Options</b> .....	90
Road Map for Phone Options .....	91
Activating Pager Mode .....	92
Selecting Preferred Call Mode .....	93
Viewing Your Own Number .....	94
Switching Between Numbers .....	94
Reviewing Feature Settings .....	95
Activating Automatic Hands-Free .....	96
Activating Multiple Key Answer .....	97
Deactivating Open to Answer .....	97
Activating Automatic Answer .....	98
Selecting Battery Options—Status Light .....	99
Displaying System Identification .....	99
Selecting a Language .....	100
<b>Selecting a Network</b> .....	101
Road Map for Selecting a Network .....	102
Performing a Manual Network Search .....	103
Selecting a New Network .....	104
Selecting a Public Network .....	105
Specifying an Automatic Search .....	106
Viewing All Non-Public Networks .....	106

**Using the Message Center** ..... 107

- Road Map for Message Center ..... 108
- Voice Mail Alerts ..... 109
- Dialing Voice Mail ..... 109
- Reading and Managing Text Messages ..... 110
- Sending Text Messages ..... 119
- Sending, Creating, Editing,  
and Deleting Quick Notes ..... 122
- Reading and Sending Draft Messages ..... 125
- Reviewing Messages in Your Outbox ..... 126
- Deleting Unsent Messages from the  
Outbox ..... 131
- Editing the Voice Mail Number ..... 132

**Reference Information** ..... 133

- Accessory Options ..... 133
- Troubleshooting ..... 136

**Glossary** ..... 138

**Patent Information** ..... 152

**Index** ..... 155

# Safety Information

---

**Important:** Read this information before using your wireless handheld phone.

## ***Exposure to Radio Frequency Signals***

Your wireless handheld portable telephone is a low power radio transmitter and receiver. When it is ON, it receives and also sends out radio frequency (RF) signals.

In August 1996, The Federal Communications Commission (FCC) adopted RF exposure guidelines with safety levels for handheld wireless phones. Those guidelines are consistent with safety standards previously set by both U.S. and international standards bodies:

- American National Standards Institute (ANSI) IEEE. C95. 1-1992
- National Council on Radiation Protection and Measurement (NCRP). Report 86
- International Commission on Non-Ionizing Radiation Protection (ICNIRP) 1996
- Ministry of Health (Canada), Safety Code 6

Those standards were based on comprehensive and periodic evaluations of the relevant scientific literature. For example, over 120 scientists, engineers, and physicians from universities, government health agencies, and industry reviewed the available body of research to develop the ANSI Standard (C95.1).

The design of your phone complies with the FCC guidelines (and those standards). For additional information concerning exposure to radio frequency signals, see the statement by the FDA at the end of this user guide.

To maintain compliance with FCC RF exposure guidelines, if you wear a handset on your body, use the Motorola-supplied or approved carrying case, holster, or other body-worn accessory.

If you do not use a body-worn accessory, ensure the antenna is at least one inch (2.5 centimeters) from your body when transmitting. Use of non-Motorola accessories may violate FCC RF exposure guidelines.

## ***Antenna Care***

Use only the supplied or an approved replacement antenna. Unauthorized antennas, modifications, or attachments could damage the phone and may violate FCC regulations.

## ***Phone Operation***

### ***Normal Operation***

Hold the phone as you would any other telephone, with the antenna pointed up and over your shoulder.

### ***Tips on Efficient Operation***

Observe the following guidelines to operate your phone most efficiently.

- Extend your antenna fully, if applicable.
- Do not touch the antenna unnecessarily when the phone is in use. Contact with the antenna affects call quality and may cause the phone to operate at a higher power level than otherwise needed.

## ***Batteries***

**Caution:** All batteries can cause property damage, injury, or burns if a conductive material, such as jewelry, keys or beaded chains, touches exposed terminals. The material may complete an electrical circuit and become quite hot. To protect against such unwanted current drain, exercise care in handling any charged battery, particularly when

placing it inside your pocket, purse, or other container with metal objects. When the battery is detached from the phone, your batteries are packed with a protective battery cover; please use this cover for storing your batteries when not in use.

## ***Driving***

Check the laws and regulations on the use of wireless telephones in the areas where you drive. Always obey them. Observe the following guidelines when using your phone while driving.

- Give full attention to driving--driving safely is your first responsibility.
- Use hands-free phone operation, if available.
- Pull off the road and park before making or answering a call if driving conditions so require.

## ***Electronic Devices***

Most modern electronic equipment is shielded from RF signals. However, certain equipment may not be shielded against the RF signals from your wireless phone.

## ***Pacemakers***

The Health Industry Manufacturers Association recommends that a minimum separation of six inches (6") be maintained between a handheld wireless phone and a pacemaker to avoid potential interference with the pacemaker. These recommendations are consistent with the independent research by and recommendations of Wireless Technology Research.

Persons with pacemakers:

- should ALWAYS keep the phone more than six inches from their pacemaker when the phone is turned ON
- should not carry the phone in a breast pocket



- should use the ear opposite the pacemaker to minimize the potential for interference
- should turn the phone OFF immediately if you have any reason to suspect that interference is taking place

### ***Hearing Aids***

Some digital wireless phones may interfere with some hearing aids. In the event of such interference, you may want to consult your hearing aid manufacturer to discuss alternatives.

### ***Other Medical Devices***

If you use any other personal medical device, consult the manufacturer of your device to determine if it is adequately shielded from external RF energy. Your physician may be able to assist you in obtaining this information.

Turn your phone OFF in health care facilities when any regulations posted in these areas instruct you to do so. Hospitals or health care facilities may be using equipment that could be sensitive to external RF energy.

### ***Vehicles***

RF signals may affect improperly installed or inadequately shielded electronic systems in motor vehicles. Check with the manufacturer or its representative regarding your vehicle. You should also consult the manufacturer of any equipment that has been added to your vehicle.

### ***Posted Facilities***

Turn your phone OFF in any facility where posted notices so require.

## ***Aircraft***

Switch OFF your phone before boarding an aircraft.

Airline regulations prohibit using your phone while in the air. Check and comply with the policy of your airline regarding the use of your phone while the aircraft is on the ground.

## ***Blasting Areas***

To avoid interfering with blasting operations, turn your phone OFF when in a "blasting area" or in areas posted: "Turn off two-way radio." Obey all signs and instructions.

## ***Potentially Explosive Atmospheres***

Turn your phone OFF, do not remove your battery when you are in any area with a potentially explosive atmosphere, and obey all signs and instructions. Sparks from your battery in such areas could cause an explosion or fire resulting in bodily injury or even death.

Areas with a potentially explosive atmosphere are often but not always clearly marked. They include: fueling areas such as gasoline stations; below deck on boats; fuel or chemical transfer or storage facilities; areas where fuel odors are present (for example, if a gas/propane leak occurs in a car or home); areas where the air contains chemicals or particles, such as grain, dust, or metal powders; and any other area where you normally would be advised to turn off your vehicle engine.

## ***For Vehicles Equipped with an Air Bag***

An air bag inflates with great force. Do NOT place objects, including both installed or portable wireless equipment, in the area over the air bag or in the air bag deployment area. If in-vehicle wireless equipment is improperly installed and the air bag inflates, serious injury could result.

US021600

## Package Content Options

Your TDMA digital StarTAC™ cellular phone is typically packed with a transformer charger and at least one battery. Below is a sampling of the different package options.

**Note:** Your phone and accessories may not look exactly as pictured.



TDMA digital  
StarTAC™ Cellular  
Telephone



Slim Main Battery  
with Battery Cover



Standard Main Battery  
with Battery Cover



AC Adapter



Slim Auxiliary Battery  
with Battery Cover



Holster



Vehicle Power  
Adapter



Headset



Desktop Charger  
(AC Adapter required)

## Phone Overview

See “Phone Diagram” on page 13 for an illustration of the components described below.

**Antenna**—Provides superior connectability.

**Earpiece**—Ultra-compact phone speaker.

**Accessory Connector Port**—Provides the connections for an external power supply and vehicular and optional accessories.

**Headset Jack**—Connects to an optional headset.

**Microphone**—Positioned for convenient conversation.

### Function Keys

 **PWR**—Turns the phone On and Off.

 **FCN**—Acts as a “shift” key to access the secondary functions of other keys.



 **RCL**—Recalls phone numbers from memory.

 **STO**—Stores phone numbers into memory.



 **CLR**—Clears characters from the screen.



 **END**—Ends phone calls.

 **SEND**—Places or answers calls.

 **#** and  **\***—Can be used to scroll through memory entries and menu features.

 **Message Center Button**—Allows access to digital messages and voice mail messages.

 **Smart Button**—Use the Smart Button to recall information from memory, place and end calls, select menu features, and toggle features on and off. The symbol  in your display represents the Smart Button.

 and  **Volume Keys**—The upper and lower volume keys can adjust keypad, earpiece, and ringer volume. After pressing the Smart Button, the volume keys also scroll through memory entries and menu features.

# Phone Diagram



# Understanding the Guide

## Key Presses

Key presses are represented in this guide using symbols so that you may locate and use the required sequence quickly. A sequence of key presses may be shown as follows:

**FCN** **0**<sub>OPR</sub> **7**<sub>PRG</sub> **CLR**

This means you should press **FCN** followed by **0**<sub>OPR</sub>, **7**<sub>PRG</sub>, and then **CLR**, in sequence, not simultaneously.

## Prompts and Messages

Your phone responds to key presses by displaying either a prompt that guides you to the next action or a message confirming that your action is complete. Prompts and messages are represented in this guide in LCD style, for example `Reset Timer`.

## Short Cuts and Tips

In the margins of your guide are short cuts and useful hints and ways to improve your phone's performance. These are especially helpful for experienced Motorola Users, who can find many of the same key sequences used with other Motorola models.

# Using the Battery

---

## About Your Batteries

Your TDMA digital StarTAC™ phone uses Lithium Ion (Lilon) batteries. Batteries are available in Slim and Extra Capacity sizes.

Your phone can use two batteries at the same time. You can use:

- any single main battery alone
- or**
- a main and auxiliary battery combination

to fit your needs. You can attach an auxiliary battery at any time, without interrupting your call.

## Storing and Disposing of Batteries

To prolong the life of your batteries, do not expose them to temperatures below -10°C (14°F) or above 45°C (113°F). Always take your phone with you when you leave your car.

To dispose of batteries, check with your local recycling center for a battery recycler near you. Never dispose of batteries in a fire.

**Caution:** To prevent injuries or burns, do not allow metal objects to contact or short-circuit the battery terminals.

## Removing and Attaching Battery Covers

Your phone's batteries are shipped uncharged and fitted with protective covers. Before you install the batteries, remove these covers, and save them for storing unused batteries. The covers prevent metal objects from contacting the battery terminals, reducing the risk of injury or damage from a battery short circuit.

### Removing the Main Battery Cover

1. Press in the release latch.
2. Rotate the battery upward and lift it out of the cover.

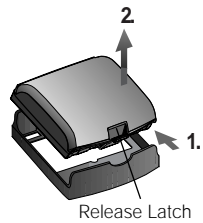

### Attaching the Main Battery Cover

1. Lower the edge of the battery opposite the release latch into the cover.
2. Drop the side with the release latch down until the latch clicks into place.

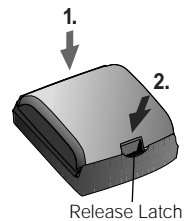



## Removing the Auxiliary Battery Cover

1. Hold the auxiliary battery securely.
2. Push up on the bottom of the cover.
3. Continue pushing until the cover slides free of the pins on the bottom of the battery, and swing the cover away from the battery.

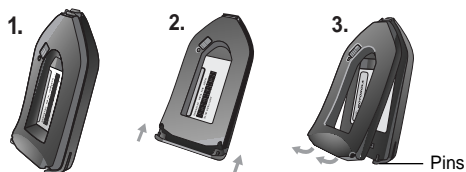

## Attaching the Auxiliary Battery Cover

1. Slide the cover's narrow end into the small grooved hook on top of the auxiliary battery.
2. Push the cover firmly downward until the base of the cover slides past the battery pins; then release.



# Installing and Removing Batteries

## Installing a Main Battery

1. Set the edge of the battery opposite the release latch into the cover.
2. Press the release latch side of the battery into the cover until the latch clicks into place

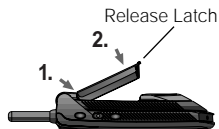

## Removing a Main Battery

1. If you don't have another battery attached, press **PWR** to turn your phone off.
2. Press the release latch back toward the battery, and lift the battery out.



## Installing an Auxiliary Battery

The auxiliary battery clips onto the back of your phone.

1. Place the hook located on the narrow end of the battery into the slot on the back of the phone.
2. Pull the battery toward the bottom of the phone and slide the battery pins over the bottom of the phone.
3. Once the battery clears the bottom of the phone, release it. Make sure that the pins fit securely into place.

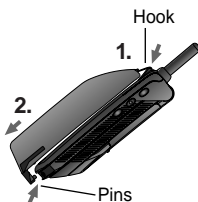

## Removing an Auxiliary Battery

1. Pull the battery down until the pins release from the base of the phone, and pull the base away from the phone.

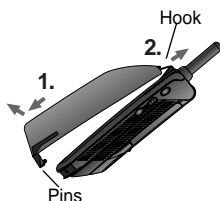

2. Lift the battery's hook out of the slot on the back of the phone.

## Checking Battery Levels

### Battery Level Indicator

The three bar segments on your phone's Battery Level Indicator display the amount of charge remaining in your battery. The more segments visible, the greater the charge.

For a detailed battery level reading:

Press **FCN** **4** **BATT** **CH**.

One of the following is displayed:



The more segments filled on the battery gauge, the greater the charge.

### Low Battery Warning

When the battery level is low and only a few minutes of time to talk, your phone signals you in three ways:

- **Low Battery** appears in the first line of the display.
- No bar segments are highlighted.
- A short tone plays periodically.



High



Low

To confirm low battery signals:

Press **FCN** **4 BATT CH**.

## Power Status Messages

You may also see one of the following messages:

Auxiliary	Auxiliary and/or main batteries fitted; phone is operating from auxiliary battery.
Main	Auxiliary and/or main batteries fitted; phone is operating from main battery.
Charging Auxiliary	Auxiliary and main batteries fitted; auxiliary battery is being charged.
Charging Main	Auxiliary and/or main batteries fitted; main battery is being charged.

## Charging Batteries

### Using the Internal Charger

Your phone has a built-in battery charger. Using either the AC or vehicle power adapter, you can plug the handset directly into a power source to charge any attached batteries.

To charge:

1. Plug the AC adapter or vehicle power adapter into the accessory connector on the bottom of your phone as shown, with the release tab facing up.

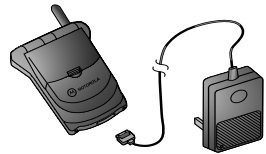

### Tip:

*You can still place and answer calls while using either the internal charger or the vehicle power adapter. Remember that talking on the phone requires energy, so charging takes more time. To place the phone in charger-only mode, turn off the phone by pressing **PWR** once.*

2. Plug the power adapter into a 110V AC electrical outlet.

or

Plug the vehicle power adapter into the power adapter plug in the vehicle.

In both cases, a beep-tone sounds, and the battery icon flashes.

## Using the Desktop Charger

You can use the desktop charger to charge batteries while they are attached to your phone, or you can charge a main battery separately.

To charge:

1. Plug the AC adapter into the back of the charger, release tab facing up.
2. Plug the other end of the adapter into an AC wall socket.
3. With battery(ies) attached, place the phone into the charger's pocket.



### Tip:

*If both a main and auxiliary battery are attached, the main battery is charged to 90% before the auxiliary is charged.*

**Note:** When the phone is charging, the battery level indicator flashes. When the battery is fully charged, this icon stops flashing. If your phone cannot charge the battery, this indicator does not appear.

## Charging Two Batteries on the Phone

When you charge your phone with a main and auxiliary battery attached, the main battery is charged first.

To find out which battery is being charged:

Press **FCN** **4 BATT CHG**.

**Note:** If the battery cannot be charged and you press **FCN** **4 BATT CHG**, you see Invalid Battery.

**Tip:** "batt" is printed on the **4 BATT CHG** key as a reminder.

## ***Battery Charging Tips***

To ensure that you enjoy maximum battery life and use your battery to its fullest capacity:

- Always use Motorola approved battery chargers.
- For the best results, Li-Ion batteries should be charged using the E•P™ Desktop Charger or your phone's internal charger.
- The battery should be at or near room temperature when charging.
- When you don't intend to use a battery for a while, store it uncharged in a cool, dark, dry place, such as a refrigerator.
- Battery life depends on the battery used, network configuration, signal strength, and the features selected. Talking or using features on the phone uses more power than leaving it idle.
- Your phone operates more efficiently in digital mode than in analog mode.

## ***Quick Change Power Source ("Seamless Connection")***

The quick change feature enables you to switch power sources while a call is in progress without losing the call. If you hear a low-battery warning while you are in a call, plug in the vehicle power adapter or AC Adapter.

# Using the Phone

---

## Turning the Phone On and Off

1. Open your phone to expose the keypad.
2. To turn the phone on, press and hold until the display appears and you hear an audible alert.
3. Press and hold again to turn the phone off. *Powering off* is displayed, and you hear an audible alert.



### What You Will See

When you turn on your TDMA digital StarTAC™ phone, it performs a self-test to let you know it is operational. When the test is completed, the phone displays:

- one of several possible greetings, such as:
  - the name of your Service Provider
- or**
- an indication of local or non-local coverage area
- your phone number
- the Digital icon

# Reading the Indicators

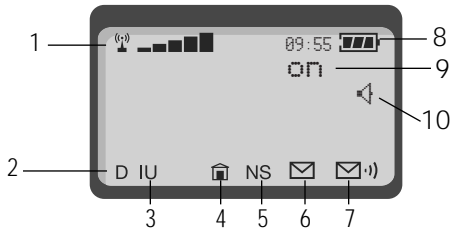

High



Low

D

## ***Signal Strength Indicator (1)***

The Signal Strength Indicator (SSI) indicates the strength of your phone's connection with the local cellular system. A strong signal increases your chances of placing and receiving calls. Low signal strength can occur in a fringe area of the cellular system. Buildings, tunnels, and bad weather can block or interfere with reception.

## ***Digital Indicator (2)***

If you are in a digital coverage area, the digital indicator appears.

IU

## ***In Use Indicator (3)***

The In Use (IU) Indicator appears when a call is in progress.



## ***In-Building Indicator (4)***

The In-Building Indicator lights when the phone accesses an In-Building Cellular System or other non-public system.

NS

## ***No Service Indicator (5)***

If you travel beyond the range of a cellular system, the No Service Indicator appears to let you know that calls cannot be placed or received from your location.



## **SMS Message Waiting Indicator (6)**

The Short Message Service (SMS) Message Waiting Indicator is displayed when the phone receives a message. (This is an optional, network- and subscription-dependent feature that is not available in all areas.)



## **Voice Message Waiting Indicator(7)**

The Voice Message Waiting Indicator is displayed when you receive a voice mail message. (This is an optional, network- and subscription-dependent feature that is not available in all areas.)



## **Battery Level Indicator (8)**

The three bar segments on the Battery Level Indicator show the amount of charge remaining in your battery. The more segments you see, the greater the charge. The phone alerts you to a low charge in three ways:



High

- No bar segments are highlighted.
- Low Battery is displayed.
- A short tone plays periodically.



Low

## **Alphanumeric Display (9)**

The middle area of the display shows input from the keypad, information recalled from memory, and other messages.

## **VibraCall® Alert Indicator (10)**

One of the VibraCall® alert combinations appears in the display:



**VibraCall® on**—Your phone's ringer is turned off, and the VibraCall® alert is on.



**Vibrate then ring**—Both your phone's ringer and the VibraCall® alert are on.



**Ring only**—Your phone's ringer is turned on, and the VibraCall® alert is turned off.



**Ring and vibrate off**—Both your phone's ringer and the VibraCall® alert are turned off.

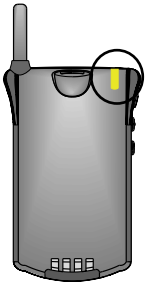

## Power/Status Indicator

The Power/Status indicator on top of the phone provides information on your current type of service and message status. Messages can include voice mails and Short Message Services (SMS) messages or the receipt of recent calls. (This is an optional, network- and subscription-dependent feature that is not available in all areas.)

During wake-up and while the phone is ringing, the indicator flashes red and green. Otherwise, if the cover is closed and the **Status Light** setting is set to **On**, then the Power/Status Indicator flashes as shown below. (See “Selecting Battery Options—Status Light” on page 99 for information on the status indicator.)

Service	Condition	First Flash	Second Flash
Service in home system	No message	Green	Green
	Message waiting		Red
Roaming (service in non-home system)	No message	Yellow	Yellow
	Message waiting		Red
No service	No message	Red	Off
	Message waiting		Red

**Note:** The Power/Status Indicator is Off when the phone is open or in charger-only mode, or when the status light feature is turned off.

## *Standby Mode*

To conserve energy, your phone may turn off its lights when in standby mode. The display backlight comes back on the next time you press a key or open the phone.

## *Storing Your Phone in Its Holster*

To store your phone in its holster, make sure the main battery is facing the inside of the holster. Then clip the holster onto a belt, purse or briefcase.

### **Notes:**

- For body-worn use, keep the antenna at least one inch from your body when transmitting.
- The holster has been designed for your convenience and is not meant to secure your phone under all circumstances.

## *Using the Smart Button*

Use the Smart Button to place and end calls, enter menus, toggle features on and off, and select items in the display. The Smart Button is the middle key on the left side of your phone.

The symbol \* in your display represents the Smart Button.

## *Selecting Items in the Display*

The most basic use of the Smart Button is for making selections. Whenever you are given a choice such as a ringer setting, press the Smart Button to select the setting you want.

## *Toggling Features On and Off*

Some features toggle on and off. Use the upper or lower volume key to scroll to the desired feature, then press the Smart Button to select it.

**Tip:** You can also enter the menu system by pressing



## Entering the Menu System

Press **FCN**, then press to access the menu. You see **Recent Calls**.

## Placing and Ending a Call

Use the Smart Button to place and end a call, as described in “Placing a Call” on page 28 and “Ending a Call” on page 29.

## Placing a Call

To place a call:

1. Power the phone on by pressing and holding until the display appears and you hear an audible alert.
2. Enter the number you want to call.

If you make a mistake, press **CLR** to erase one digit at a time. Press and hold **CLR** to clear the entire entry.

You can also recall a previously dialed or stored number. (See “Using Phone Memory” on page 33 for details.)

3. To place the call, press and hold until you hear two tones.

**or**

Press **SEND**.

You hear a single-tone alert (if keypad tones are turned on) and see **Dialing** .

4. You can dial phone numbers with up to 32 digits, but only the last 20 digits appear in the display.



Press **RCL** to see the entire phone number.

## Ending a Call

To end a call:

Press **END** or close the phone.

**or**

1. Press and hold  until you hear two tones.  
You see \* To End Call.
2. Press  again to end the call.

## Receiving a Call

Your phone must be powered on to receive calls. To answer a call:

When the phone rings, press **SEND** or open the phone.

**Note:** Opening the phone does not answer the call if the Open to Answer feature is off. (See “Deactivating Open to Answer” on page 97.)

## Unanswered Call Indicator

When you cannot take a call, your phone keeps a count of your unanswered calls and displays Missed *XX* Calls, where *XX* is the number of missed calls.

Press  to view missed calls.

## Terminating the Ring or Vibrate Alert

You can terminate either the ring or the vibrate alert by pressing either of the volume keys during the ring/vibrate cycle.

## Switching Between Digital and Analog Modes

To switch from digital to analog model during a call:

Press **FCN** **2**.

Depending upon availability, your phone selects the TDMA digital system or the analog system.

### Notes:

- Your battery use increases significantly in analog mode.
- This feature is not available on all models of this phone.
- Once you switch from digital to analog mode, you can not switch back to digital mode until you turn your phone off and on again.
- When you switch from digital to analog mode, you may still see the digital **D** indicator while the phone is idle (that is, not in an active call).

## Redialing a Number Automatically



A fast busy signal indicates that the cellular system is busy. With Automatic Redial, your phone calls continuously for the next four minutes.

When it makes a connection, the phone rings or vibrates. This ring is half as long as the ring or vibrate for a new incoming call. When the other party answers, you can begin talking.

### If you hear a fast busy signal:



1. You see **Redial Call?**

Press **OK** or **SEND** to redial, or press **END** to exit.

2. If the call does not go through after four minutes, press , or press  to continue the call attempt.

You see *Redial*.

### **If you hear an ordinary busy signal:**

1. Press  to hang up.
2. Press  or  to redial the busy number.



You see *Dialing* .

## *Controlling Volume*



### ***Adjusting Volume***

Use the upper and lower volume keys to adjust earpiece, keypad, and ringer volume. When you press these keys, the phone's speaker demonstrates the current volume level.

#### **To adjust earpiece and keypad volume:**





Press  or  to raise or lower the volume.

#### **To adjust the ringer volume:**

1. Press .
2. Press  or  to raise or lower ringer volume.

### ***Muting the Microphone***

For privacy during a call, mute the microphone. You can hear the person on the other end, but he or she cannot hear you.

1. Press   to mute the microphone. You see *Mute*.
2. Press   again to resume normal conversation.

## **Selecting Silent Vibration Mode**

When you don't want your phone to ring, or in noisy locations where you may not hear your phone, select the VibraCall® Alert function for discreet vibration:

Press **FCN** **8** **8** to toggle between ring and vibration mode. Your phone displays either Ring only or Vibrate only.



# Using Phone Memory

---



Use your TDMA digital StarTAC™ phone's internal Phone Book to store up to 99 names and numbers for easy access.

In this chapter you will learn how to:

- store names and numbers into the Phone Book
- recall phone numbers from memory
- clear names and numbers
- dial a number with Speed Dial and Turbo Dial®
- make notes on the scratchpad

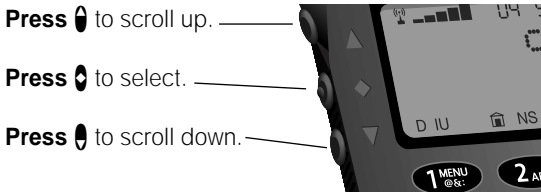
Follow these symbols as a guide for using the keys on the side of your phone:



You can also use your phone's  and  keys to scroll through the menu system.

## *Using Your Phone's Built-in Phone Book*

Each phone number in your phone book is stored in a *memory location* numbered 01-99.

Arrange numbers for easy recall by storing related numbers in groups. If you store the numbers you call most in locations 01-09, then you can use Turbo Dial® to call those numbers with a single key. (See "Using the Turbo Dial® Function" on page 39 for details.)

You can also store names to identify phone numbers. Later, you can recall a number by the name that corresponds to it.

## *Storing Names and Numbers*

### ***How to Store a Phone Number***

1. Enter the phone number you want to store.

**Note:** You can store up to 32 digits per phone number entry.

2. Press **STO** to begin storing.

The phone prompts you to enter a memory location. You see *Location* \_.

3. Enter the two-digit memory location where you want the sequence stored.



**or**

Press  to store the sequence in the first available location.

**or**

Enter the first digit of the memory location, then press  to store the sequence in the first available location beginning with that digit.

You see Enter Name: .

4. Enter a name to identify the phone number. (See the following section for details on entering names.)
5. Press  or  when you finish entering the name.

Your phone confirms your entry by displaying the information you stored.

**Tip:** The  symbol in your display represents the Smart Button.

## How to Enter Text

You can press the numeric keys one or more times to produce any letter or number in the alphabet, using the letters printed on each key as a guide. For example, press **2<sub>ABC</sub>** to enter "A," "B," "C," or "2" as shown:

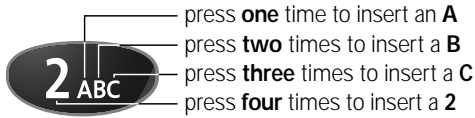



### Tip:

*Press the upper or lower volume key first, to toggle between upper and lower case letters.*

1. Press the appropriate keys to generate the characters shown.

<b>1</b> MENU ESC	Space . 1 ? ! , @ & : ; " ( ) ' ` ~ ! % \$ _
<b>2</b> ABC	A B C 2 a b c 2
<b>3</b> DEF	D E F 3 d e f 3
<b>4</b> BATT CHG	G H I 4 g h i 4
<b>5</b> LOCK JKL	J K L 5 j k l 5
<b>6</b> MUTE MNO	M N O 6 m n o 6
<b>7</b> POKS	P Q R S 7 p q r s 7
<b>8</b> VIB TUV	T U V 8 t u v 8
<b>9</b> WXYZ	W X Y Z 9 w x y z 9
<b>0</b> OPS	+ - 0 x * / = > < # _

The top line for each key shows the upper case characters, the lower line shows the lower case characters. Press  or  to toggle between upper and lower case letters.

You can use the **FCN** key to toggle among different typing modes. A Shift indicator shows the currently selected typing mode. A counter beside the Shift indicator shows the number of free spaces remaining for input.

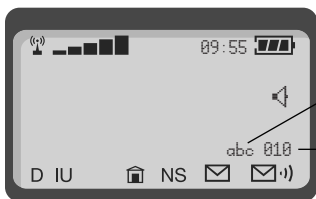

Shift Indicator

Character Counter

FCN Key Presses	Mode Selected	Result When Entering Characters	Shift Indicator Displays
1	lowercase	all characters are lower case	abc
2	Shift	first character is upper case, all following are lower case	Abc
3	Caps Lock	all characters are upper case	ABC
4	NumLock	all characters are numbers	123

The cursor advances automatically to the next space after you enter a letter or after a short period of inactivity. If you are repeating a character, then press **# ▶** to advance the cursor to the next space.



2. Press **◀ ✖** to move back or **CLR** to erase a letter if you make an error.
3. Press **↵** or **STO** when you finish entering text.

## Recalling an Entry by Name



After storing names and numbers, you can recall them alphabetically and immediately place calls. Use the Smart Button for instant access to the name directory.

1. Press  once to enter your name directory.
2. Enter the first letter of the name you want to recall. The display shows the first name in the phone book that begins with that letter.

If no entry is found beginning with a particular letter, then a message is displayed. For example, if no name begins with the letter A, then  is displayed.



3. Press  or  to scroll to the name you want.

When the name is displayed, the corresponding number is displayed on a third line, and the phone memory location is displayed in the upper right corner.

4. Press and hold , or press , to call the number you selected.

## Recalling an Entry by Memory Location

Each name and number you store is placed in a memory location numbered 01-99. Once you have stored names and numbers, you can recall them by memory location:

1. Press .
2. Enter the two-digit memory location of the phone number you want.
3. Press and hold , or press  to call the number you selected.

## Clearing a Phone Memory Entry

1. Recall by name the entry that you want to erase. (See "Recalling an Entry by Name" on page 38.)
2. Press **CLR** to clear the entry.  
You will see Delete Entry?.
3. Press **↵** or **STO** to confirm that you want to erase the entry.

The numbered location of the cleared entry is shown in the display.

**or**

Press **END** to exit without clearing the entry.

## Shortcuts for Recalling Phone Book Entries

### Using Speed Dial

If you know the memory location of the number you want to call, try the Speed Dial function:

1. Enter the two-digit memory location (01-99).
2. Press and hold **↵**, or press **SEND** to place the call.

### Using the Turbo Dial<sup>®</sup> Function

The Turbo Dial<sup>®</sup> function enables you to dial numbers stored in locations 01-09 with the push of a single button:

Press and hold a number **1 MENU** through **9 WXYZ** on the keypad, and your call is placed. You will hear a two-tone alert afterwards.

Your phone's Priority Call feature gives you fast access to any number stored in location 01. To learn more about this feature, see "Activating Priority Calling" on page 84.

## *Making Notes on the Scratchpad*

In addition to your internal phone book, you also have a built-in scratchpad for making quick notes. The scratchpad remembers the last phone number shown on your display.

### ***Entering a Number in the Scratchpad***

If you are on the phone and your party gives you another number to call, enter the number on the scratchpad so you can place the call later.

1. Enter the number into the keypad. (The person on the line can hear tones as you dial.)
2. Press **END** to end the current call, if necessary.
3. Press **SEND** to call the number you saved on the Scratchpad.

### ***Storing Numbers During a Call***

You can also store numbers during a call:

1. Enter the number into the keypad. (The person on the line can hear tones as you dial.)
2. Press **STO** and continue storing with step 3 in “Storing Names and Numbers” on page 34.



# Using the Menu System

---

Your TDMA digital StarTAC™ cellular phone includes many features to help you be more productive. The phone's user-friendly menu system helps you find what you need quickly and easily.

In this chapter you will learn:

- what are the main menu features
- how to navigate through the menus
- how to read a menu road map

## Introducing the Menu Features

As you scroll through the menu system, you will see the following icons, each representing a high-level menu.



Recent Calls



Phone Book



Timers



Tone Control



Lock Secure



Phone Options



Network Selection



Time and Date

## Navigating the Menu

You can navigate through the menu system using the three keys located on the left side of the phone. Use the upper and lower volume keys to scroll to sub-menus and to control volume. Use the middle Smart Button to choose menus and functions.



Follow these symbols as a guide for using the keys on the side of your phone:

Press  to scroll up. \_\_\_\_\_

Press  to select. \_\_\_\_\_

Press  to scroll down. \_\_\_\_\_





You can also use your phone's  and  keys to scroll through the menu system.





## Road Maps

To help you navigate through the phone's menu system, each chapter begins with an easy-to-follow visual "road map." Simply press the key shown, and observe the message that appears in the display. For example, try this:

1. Press , then press  to enter the menu features

or

Press  . "menu" is printed on the  key as a reminder.

2. Press  or  to scroll through the menu's top level, shown here in the margin.
3. Press  to select a menu item.
4. Press  to exit the menu.

Detailed instructions within each chapter describe how each feature works.

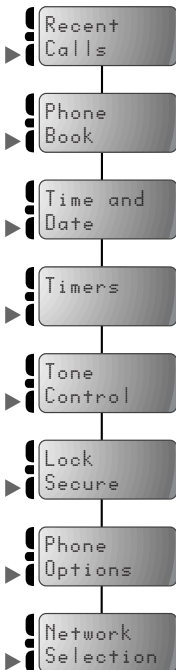

# Managing Recent Calls

---

The recent calls menu option allows you to access your Caller Line ID and review previous calls. Caller Line ID is an optional network and subscription-dependent feature that is not available in all areas.

In this chapter you will learn how to review all calls that you have received or dialed.



Follow these symbols as a guide for using the keys on the side of your phone:

**Press**  to scroll up. \_\_\_\_\_

**Press**  to select. \_\_\_\_\_

**Press**  to scroll down. \_\_\_\_\_



You can also use your phone's  and  keys to scroll through the menu system.

## Road Map for Recent Calls

To enter the menu system:

Press **FCN**, then press **↕**.

or

Press **FCN** **1 MENU**.

Start:

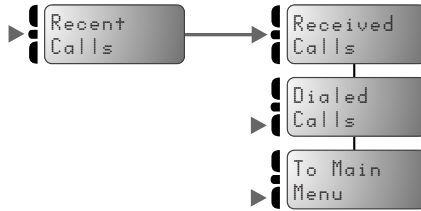

## About Recent Calls

The Recent Calls menu allows you to review previous calls that you have received or dialed. Following are some useful tips and information about reviewing recent calls.

- To view Caller Line ID information prior to answering a call, you must turn off the Open to Answer feature. (See "Deactivating Open to Answer" on page 97.)
- Your TDMA digital StarTAC™ cellular phone can store the telephone numbers and names of the last thirty incoming calls.
- If the caller's phone number matches a phone number stored in the phone's memory, the phone automatically displays the name associated with that phone number.

- If you subscribe to call waiting and receive a call while another call is in progress:
  - You hear a call waiting tone.
  - The caller's name and number are displayed.
  - The name and number are automatically stored and can be viewed after ending the call, using the procedure described in "Reviewing Received Calls" on page 46.
- Caller Line ID allows you to view the name and number of the calling party in the phone's display while the phone is ringing.

Caller Line ID is an optional feature that is not available in all markets. Contact your Service Provider for availability information.

- If the caller has restricted transmission of the phone number, your phone displays **Anonymous**. If the Calling Number ID information is not available to the cellular network, your phone displays **Unavailable**.
- You can store any number contained in your Caller Line ID memory to a memory location in the same way you would save any phone number. Once the correct number is displayed, press **STO** and a memory location or **STO** **◀\*** to autoload. See "Storing with the Menu" on page 52 for more information on storing phone numbers.

# Getting to Recent Calls

1. Press **FCN**, then press **⏏** to enter the menu system.
2. When you see **Recent Calls**, press **⏏** to select.
3. Press **⏏** or **⏏** to scroll to the following features.

## Shortcut:

Press **RCL** **RCL** to view your received calls. You must hold the second **RCL** until the received call list is displayed.

## Reviewing Received Calls

1. Follow the steps in "Getting to Recent Calls" above to scroll to **Received Calls**. The total numbers of received calls stored is displayed in the upper right corner. If there are no numbers in the Caller Line ID list, you see **00** in the upper right corner.
2. Press **⏏** to enter your Caller Line ID list of received calls.
3. Press **⏏** or **⏏** to scroll through the list.

The phone displays a number in the upper right corner that indicates the order in which the call was received,

The received call list can range from **01** (the most recent received phone call) to **30** (the least recent phone call).

Your phone also displays the time and date of the incoming call.

If you have caller ID, your phone displays:

- the phone number (if available) of the calling party

**or**

- the name of the calling party, if the name is stored in your phone book

To view the number, press **RCL**. Your phone displays the name, then the number.

The following symbols appear next to the received calls:



Answered



Missed

4. Press **SEND** to dial the displayed number.

## Reviewing Dialed Calls

1. Follow the steps in "Getting to Recent Calls" on page 46 to scroll to **Dialed Calls**.

The total number of dialed calls that are stored is displayed in the upper right corner. You can see up to the last twenty numbers dialed. If there are no numbers in the Dialed Call list, you see 00.

2. Press **UP** to enter your dialed calls list.
3. Press **DOWN** or **LEFT** to scroll through the list.

The phone displays the order of the previously dialed phone call in the upper right corner.

The dialed call list can range from 01 (the most recent dialed phone call) to 20 (the least recent dialed phone call).

Your phone also displays the time and date of the outgoing call.

If you have caller ID, your phone displays:

- the phone number (if available) of the calling party

**or**

- the name of the calling party, if the name is stored in your phone book

To view the number, press **RCL**. Your phone displays the name, then the number.

4. Press **SEND** to dial the displayed number.

### Shortcut:

Press **RCL** **0** **OPR** to enter your dialed calls list.

## Getting to Recent Calls

1. Press **FCN**, then press **↓** to enter the menu system.
2. When you see **Recent Calls**, press **↓** to select.
3. Press **↑** or **↓** to scroll to the following features.

**Tip:** To erase **all** entries you must press and hold **CLR**, whereas to erase a **single** entry you simply press **CLR**.

### Clearing Caller Line ID

To **erase all entries** saved in your Caller Line ID memory:

1. Follow the steps in “Getting to Recent Calls” above to scroll to **Received Calls**.
2. Press and hold **CLR** when a Caller Line ID name and number is displayed. You see **Delete All?**.
3. Press **↓** or **STO** to clear.

**or**

Press **END** to leave your Caller Line ID memory intact.

To **erase a single entry** saved in your Caller Line ID memory:

1. Press **CLR** or any other key when a Caller Line ID name and number is displayed. You see **Delete Entry?**.
2. Press **↓** or **STO** to clear.

**or**

Press **END** to leave your Caller Line ID memory intact.



# Managing the Phone Book



In "Using Phone Memory" you learned how to store and recall phone numbers with the internal Phone Book. You can access the same features, along with several advanced features, using your phone's convenient menu system.

In this chapter you will learn how to:

- recall and store phone numbers using the menu system
- store numbers with pause dialing
- store calling card sequences for easy access
- edit your memory information
- select the individual ringer style
- attach email addresses to phone book entries

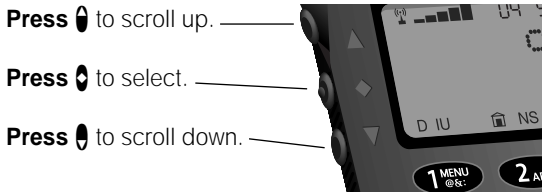
Follow these symbols as a guide for using the keys on the side of your phone:



You can also use your phone's  and  keys to scroll through the menu system.

# Road Map for Phone Book

To enter the menu system:

Press **FCN**, then press **↕**.

or

Press **FCN** **1 MENU**.

Start:

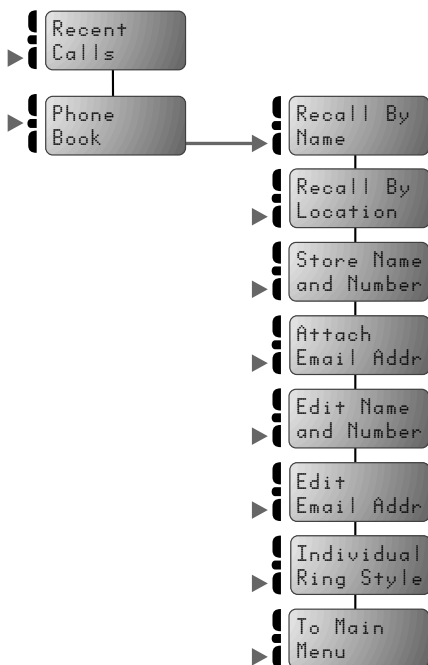

## Getting to Phone Book

1. Press **FCN**, then press **⏮** to enter the menu system.
2. Press **⏮** or **⏭** to scroll to **Phone Book**, and press **⏮** to select.
3. Press **⏮** or **⏭** to scroll to the following features, and press **⏮** to select.

### Recalling an Entry by Name

To recall a stored name with the Phone Book menu:

1. Follow the steps in "Getting to Phone Book" above to select **Recall By Name**. You see **Enter 1st Letter**.
2. Enter the first letter of the name you want to recall. Your phone displays the first name in the phone book that begins with that letter. If no entry beginning with that letter is found, **No A's** is displayed.
3. Press **⏮** or **⏭** to scroll to the name you want.
4. Press and hold **⏮**, or press **SEND** to call the number you selected.

### Recalling an Entry by Location







Each name and number you store is placed in a memory location numbered 01-99. After storing names and numbers, you can recall them by memory location with the Phone Book menu.

1. Follow the steps in "Getting to Phone Book" above to select **Recall By Location**. You see **Location \_**.
2. Enter the two-digit memory location of the number you want.
3. Press and hold **⏮**, or press **SEND**, to call the number you selected.

**Shortcut:** You can recall phone numbers without using the Phone Book. See "Recalling an Entry by Name" on page 38 or "Recalling an Entry by Memory Location" on page 38.



**Tip:** Select a *Phone Book* entry and press **ⓧ** to send a text message. Refer to "Sending Text Messages" on page 119.

## Getting to Phone Book



1. Press **FCN**, then **press**  to enter the menu system.
2. Press  or  to scroll to **Phone Book**, and **press**  to select.
3. Press  or  to scroll to the following features, and **press**  to select.

### *Storing with the Menu*

Use the phone's menu system to store names and numbers into the Phone Book.

1. Follow the steps in "Getting to Phone Book" above to select **Store Name and Number**. You see **Enter Number**.
2. Enter the phone number you want to store. (See "How to Store a Phone Number" on page 34.)
3. Press  when you finish entering the number. You see **Location ...**.
4. Press   to store the sequence in the next available location.

**or**

Enter the first digit of the memory location and press   to store the sequence in the first available location beginning with that digit.

**or**

Enter the two-digit memory location where you want the sequence stored.

5. When you see **Enter Name:**, enter a name to identify the phone number. (See “How to Enter Text” on page 36.)
6. Press **↵**, or **STO**, when you finish entering the name. Your phone confirms your entry by displaying the location, number, and name you stored. Proceed with step 7 below, or return to step 2 above to store more numbers.
7. Press **END** to exit the menu.

**Tip:**

*If the chosen location is full, press **END** and restart the storing sequence.*

## Storing and Placing Numbers with Pause Dialing

### Entering a Pause in a Number

When you call automated systems, a recorded message prompts you for PIN numbers, Voice Mail numbers, etc.

You can store these numbers in your phone’s memory, separated by “pauses”—special characters that tell your phone to wait before sending additional numbers.

1. Follow the steps in “Getting to Phone Book” on page 52 to select **Store Name and Number**. You see **Enter Number**.
2. Enter the phone number you use to access the automated system.
3. Press **FCN**, then press **SEND**.  
You see **Insert Wait 0**.
4. Press **↵** to insert a pause (0) into the sequence.
5. Enter the next group of numbers (such as an account number or PIN number.)
6. Enter any other required symbols (such as \* or #).

7. Insert another pause, and enter the next group of numbers by repeating steps 3 through 5 as many times as necessary.

You can store up to 32 digits, including pauses. Then store the entire sequence as you would any phone number.

8. Press **STO** to begin storing.

You see `Location ...`

9. Enter the two-digit memory location where you want the sequence stored.

You see `Enter Name: .`

10. Enter a name for your sequence. (See “How to Enter Text” on page 36.)

11. Press **⏏** when you finish entering the name.







Your phone confirms your entry by displaying the location, number, and name you stored.

## ***Placing a Call with Pauses***

To use your stored sequence:

1. Recall the stored number with the pause inserted.
2. Press and hold **⏏**, or press **SEND**, to place the call.
3. When the recording prompts you for information, press **⏏** or **SEND** to send the next set of stored numbers.
4. Press **⏏** or press **SEND** as many times as necessary, to transmit all the numbers.

## Getting to Phone Book

1. Press **FCN**, then **press**  to enter the menu system.
2. Press  or  to scroll to **Phone Book**, and **press**  to select.
3. Press  or  to scroll to the following features, and **press**  to select

## *Storing and Placing Numbers for Calling Card Information*

### **Storing Calling Card Information**

Like Pause Dialing, you can store calling card access numbers, separated by pauses, for recall later. You can also store a Number Character in the sequence to save a place for the number you call when you use your calling card.

See "Using Lock/Security Features" on page 80 for more information on protecting your calling card information.

1. Follow the steps in "Getting to Phone Book" above to select **Store Name and Number**. You see **Enter Number**.
2. Enter the phone number you use to access your calling card system. (Skip this step if you only dial 0.)
3. Press **FCN SEND**. You see **Insert Wait**.
4. Press  to insert a pause (⌋) into the sequence.
5. Enter the next numbers, if needed. (For example, some long distance carriers require you to dial a 0 first. If no further numbers are needed, skip to step 7.)
6. Press **FCN SEND**.



7. Press **0** to scroll to the Number Character. You see `Insert Number ^N`.
8. Press **0** to insert the `^N` Character.  
This special character saves a place for the phone number you will be calling. The number is inserted automatically when you place the call.
9. Press **FCN** **SEND**.
10. Press **0** to insert another pause, as in steps 3 and 4.
11. Enter your calling card PIN number.
12. Press **STO** to store your calling card sequence.  
You see `Location ...`.
13. Enter the two-digit memory location where you want the sequence stored.  
You see `Enter Name: .`
14. Enter a name for your sequence. (See "How to Enter Text" on page 36.)
15. Press **0** when you are finished entering the name.  
Your phone confirms your entry by displaying the location, number, and name you stored.

## ***Placing a Calling Card Call***



To recall your stored calling card information:

1. Recall the calling card information you stored.  
(See "Recalling an Entry by Name" and "Recalling an Entry by Location" on page 51 for more information on Recalling Numbers.)
2. Press **SEND**. You see `Enter Number`.
3. Enter the phone number you want to call, including the area code. Enter the number manually, by location, or recall.



4. Press and hold , or press , to place the call.

Your phone dials the number to access your long distance provider.







5. Press , or press , to send the next group of numbers when you are prompted.

The phone automatically inserts the selected number to call at the appropriate time in the sequence.







6. Repeat step 5 to send the next group of numbers as many times as necessary.

## *Attaching an Email Address*

You can attach email addresses to your Phone Book entries with the Phone Book menu.

1. Follow the steps in "Getting to Phone Book" on page 55 to select **Attach Email Addr.** You see **Enter 1st Letter**.
2. Enter the first letter of the name for the entry you want to modify. The display shows the first name in the phone book that begins with that letter. If no entry beginning with that letter is found, **No A's** is displayed.
3. Press  or  to scroll to the name you want.
4. Press  to select the name. You see **Email Addr.**
5. Enter the email address. (Press  repeatedly to enter symbols. See "How to Enter Text" on page 36.)
6. Press , or , when you finish entering the address. Your phone confirms your entry by displaying **Email Addr Attached.**

## Getting to Phone Book

1. Press **FCN**, then **press**  to enter the menu system.
2. Press  or  to scroll to **Phone Book**, and **press**  to select.
3. Press  or  to scroll to the following features, and **press**  to select.

### *Editing a Memory Location*

After you store names and numbers in the Phone Book, you can edit the information or erase entries at any time.

1. Follow the steps in “Getting to Phone Book” above to select *Edit Name and Number*.

2. Recall the entry by location or by name.

(See “Recalling an Entry by Name” and “Recalling an Entry by Location” on page 51.)

3. Press  to begin editing the phone number.

Your phone briefly displays the name, then the phone number.

4. Press **CLR** to erase one digit at a time.

Press and hold **CLR** to erase the entire number.

5. Enter your changes to the phone number.

6. Press  when you finish editing the phone number.

Your phone displays the location where your number is currently stored.

7. Press **CLR** to erase the memory location, then enter a new two-digit location.

**or**

Press **↵** to keep the phone number in its current location.

Your phone displays the name stored with the phone number you are editing.

8. Enter your changes to the name. (See "How to Enter Text" on page 36.)

Press **CLR** to erase one letter at a time, or skip to step 9 to leave the name unchanged.

9. Press **↵** when you finish editing the name. Your phone displays the new information.

10. Press **↵** to save your changes.







Your phone confirms your entry by displaying the location, number, and name you stored.

**or**

Press **END** to leave the information unchanged.





11. Press **END** to exit, or scroll to other features.

## Getting to Phone Book

1. Press **FCN**, then **press**  to enter the menu system.
2. Press  or  to scroll to **Phone Book**, and **press**  to select.
3. Press  or  to scroll to the following features, and **press**  to select.

### *Editing an Email Address*

After you attach an email address to a Phone Book entry, you can edit the address at any time.

1. Follow the steps in “Getting to Phone Book” above to select **Edit Email Addr.** You see **Enter 1st Letter**.
2. Enter the first letter of the name for the entry you want to modify. Your phone displays the first name in the phone book that begins with that letter. If no entry beginning with that letter is found, **No A<sup>r</sup>s** is displayed.
3. Press  or  to scroll to the name you want.
4. Press  to select the name. You see the current email address.
5. Press **CLR** to erase one character at a time.  
Press and hold **CLR** to erase the entire number.
6. Enter your changes to the email address.  
(Press **MENU** repeatedly to enter symbols. See “How to Enter Text” on page 36.)
7. Press , or **STO**, when you finish entering the address. Your phone confirms your entry by displaying **Email Addr Changed**.

# Assigning an Individual Ring Style to a Phone Book Entry

You can use the individual ring style feature to assign one of nine ring styles to alert you of an incoming call from a phone number listed in your phone book.

**Note:** This feature only operates if you subscribe to Caller ID from your Service Provider. Caller ID is not available in all areas.

1. Follow the steps in "Getting to Phone Book" on page 52 to select *Individual Ring Style*.
2. Select the phone book entry to which you want to assign an individual ring style.
  - a. Enter the first letter of the name entry associated with the phone number.
  - b. Scroll up and down to reach the desired phone book entry.
3. When you reach the phone number you want, select it by pressing  or **STO**.

Your phone displays *Press 0-9, 0=OFF*.

4. Press **0 OFF** to remove the last ring style selected.

**or**

Press an entry from **1 MENU** to **9 WYVZ** to select one of the nine ring styles. The ring style will sound.

5. Press  or **STO** to select that ring style.

Your phone confirms the selection by displaying *Ring Style Assigned*.

6. Press **END** to exit, or scroll to other features.

# Setting the Time and Date

---

The Time and Date menu lets you format and edit your phone's time and date information.

In this chapter you will learn how to:

- set the time and date
- set the date format
- set the time format
- automatically update your time and date



Follow these symbols as a guide for using the keys on the side of your phone:

**Press**  to scroll up. \_\_\_\_\_

**Press**  to select. \_\_\_\_\_

**Press**  to scroll down. \_\_\_\_\_



You can also use your phone's  and  keys to scroll through the menu system.

# Road Map for Time and Date

To enter the menu system:

Press **FCN**, then press **0**.

or

Press **FCN** **1 MENU**.

Start:

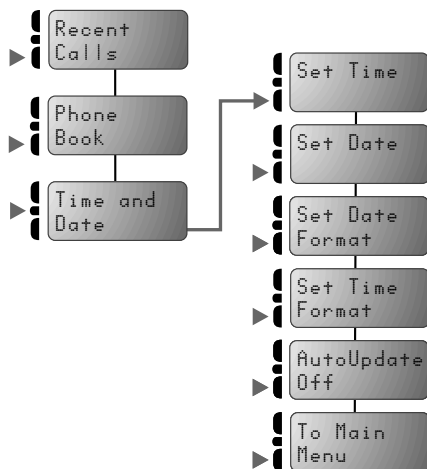

## Getting to Time and Date

1. Press **FCN**, then press **⏏** to enter the menu system.
2. Press **⏏** or **⏏** to scroll to **Time and Date**, and press **⏏** to select.
3. Press **⏏** or **⏏** to scroll to the following features, and press **⏏** to select.

### *Setting the Time*

Use this feature to manually set your phone's clock:

1. Follow the steps in "Getting to Time and Date" above to select **Set Time**. The phone displays your current Time setting, with an arrow under the hour field.

2. Press **⏏** or **⏏** to scroll to the correct hour setting.

**or**

Enter the hour on the keypad.

3. Press **⏏** to store the hour setting.

The arrow moves to the minutes field.

4. Press **⏏** or **⏏** to scroll to the correct minute setting.

**or**

Enter the minutes on the keypad.





5. Press **⏏** to store the minutes setting.

If the Time Format is set to 24-hour format, your phone now exits the time setting function. Skip to step 7.

**or**



If the Time Format is set to 12-hour format, the arrow moves to the am/pm field.



6. Press  or  to scroll to the correct am/pm setting, and press  to select it and exit the time setting display.
7. Press  to exit, or scroll to other features.



## Setting the Date

Use this feature to manually set your phone's date:

1. Follow the steps in "Getting to Time and Date" on page 64 to select **Set Date**. The phone displays the current Date setting, with an arrow under the first field.
2. Press  or  to scroll to the correct month (for *MM/DD/YYYY* date format) or day (for *DD/MM/YYYY* date format), and press  to select it. Repeat this step for the next two fields.





**or**

Enter the month or day on the keypad.

3. Press  to store the month or day, and move to the next field.
4. Repeat these steps for the next two date settings.
5. Press  to exit, or scroll to other features.

## Changing the Date Format

Your phone can display dates in a day/month/year format, or in a month/day/year format. Use this feature to select the format you want:

1. Follow the steps in "Getting to Time and Date" on page 64 to select **Set Date Format**.
2. Press  or  to scroll to the sample date that matches the format you want, and press  to select it.
3. Press  to exit, or scroll to other features.

## Getting to Time and Date

1. Press **FCN**, then press **⏏** to enter the menu system.
2. Press **⏏** or **⏏** to scroll to **Time and Date**, and press **⏏** to select.
3. Press **⏏** or **⏏** to scroll to the following features, and press **⏏** to select.

### *Changing the Time Format*

Your phone can display time in a 12-hour or 24-hour format. To select the format you want:

1. Follow the steps in “Getting to Time and Date” on page 64 to select **Set Time Format**.
2. Press **⏏** or **⏏** to scroll to the sample time format you want, and press **⏏** to select it.
3. Press **END** to exit, or scroll to other features.

### *Turning Autoupdate On and Off*

When you activate this feature, your phone updates its time and date from the network each time you turn it on.

#### **Notes:**

- If you turn Autoupdate off, you must set your phone’s clock and date manually. (See “Setting the Time” and “Setting the Date” on page 65.)
- Network updating is not available in all areas.

To turn Autoupdate On and Off:

1. Follow the steps in “Getting to Time and Date” above to select **Autoupdate**.
2. Press **⏏** to toggle the autoupdate setting on and off.
3. Press **END** to exit, or scroll to other features.

# Timing Your Calls

---



Your phone's Call Timers give you a variety of options for managing your time. You can monitor the length of individual calls, or have the phone alert you at intervals that you specify.

In this chapter you will learn how to:

- view the timers
- monitor the length of your calls
- set and view the resettable timer
- program audible timers for your individual needs

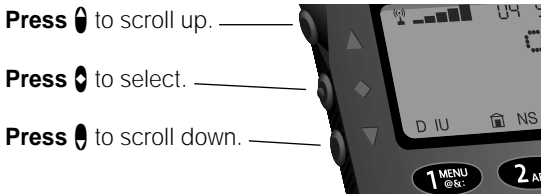
Follow these symbols as a guide for using the keys on the side of your phone:



You can also use your phone's \* and #  keys to scroll through the menu system.

# Road Map for Call Timers

To enter the menu system:

Press **FCN**, then press **↕**.

or

Press **FCN** **1 MENU**.

Start:

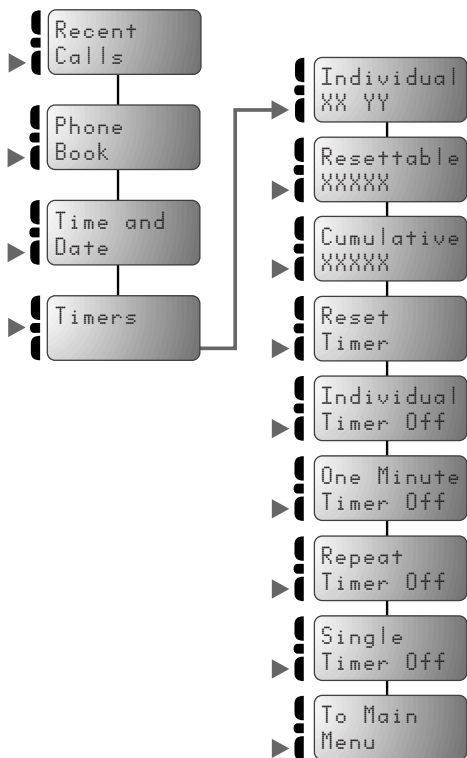

## Getting to Call Timers

1. Press **FCN**, then press **⏮** to enter the menu system.
2. Press **⏮** or **⏭** to scroll to **Timers**, and press **⏮** to select.
3. Press **⏮** or **⏭** to scroll to the following features, and press **⏮** to select.

### Viewing Call Timers

*Network connection time* is the elapsed time, in one-minute intervals, from the moment you connect to your Service Provider's network to the moment you end the call by pressing **END**. The time includes busy signals and ringing.

The amount of network connection time you track on your resettable timer may not equal the amount of time for which you will be billed by your wireless Service Provider. For billing information, please contact your Service Provider directly.

### Viewing the Individual Call Timer

You can view the network connection time of the most recent call or the call in progress (in minutes and seconds) at any time. The Individual Call Timer resets when you place the next call and when you turn the phone off.

1. Follow the steps in "Getting to Call Timers" above to select **Individual**  $MM:SS$ . The display shows the network connection time of your last call in minutes ( $MM$ ) and seconds ( $SS$ ).
2. Press **END** to exit, or scroll to other features.

You can also choose to have the timer display while calls are in progress. See "Displaying the Individual Timer Automatically" on page 71.

#### Shortcut:

Press **RCL** **#** **▶** for a quick look at this timer.

**Shortcut:**

Press **RCL** **#** **#** for a quick look at this timer.

**Shortcut:**

Press **RCL** **#** **#** **#** for a quick look at this timer.

## Viewing the Resettable Call Timer

You can track, in one-minute intervals, the approximate amount of network connection time elapsed. Use this feature to view the time elapsed, and refer to “Resetting the Timer” on page 70 to reset the timer.

1. Follow the steps in “Getting to Call Timers” on page 69 to select **Resettable** **XXXXX**. Your phone displays your network connection time in minutes (**XXXXXX**) since you last reset the timer.
2. Press **END** to exit, or scroll to other features.

Follow the instructions in “Resetting the Timer” on page 70 to reset the timer.

## Viewing the Cumulative Timer

This is a non-resettable timer that keeps track of your phone’s total network connection time (in minutes).

1. Follow the steps in “Getting to Call Timers” on page 69 to select **Cumulative** **XXXXX**. Your phone displays your network connection time in minutes since your phone was activated.
2. Press **END** to exit, or scroll to other features.

## Resetting the Timer

After you reset this timer, it continues to keep track of your network connection time (in minutes) until you reset it again.

1. Follow the steps in “Getting to Call Timers” on page 69 to select **Resettable** **XXXXX**.
2. Press **↓** to scroll to **Reset Timer**.
3. Press **↓** to reset the timer.

Your phone may display **Busy** for a few seconds.

4. Press **END** to exit, or scroll to other features.

## Getting to Call Timers

1. Press **FCN**, then press **⏮** to enter the menu system.
2. Press **⏮** or **⏭** to scroll to **Timers**, and press **⏮** to select.
3. Press **⏮** or **⏭** to scroll to the following features, and press **⏮** to select.

### *Displaying the Individual Timer Automatically*

When you turn this feature on, your phone automatically displays your network connection time in minutes (MM) and seconds (SS) during and after each call.

1. Follow the steps in "Getting to Call Timers" above to select **Individual Timer**. You see **Individual Timer Off** or **Individual Timer On**.
2. Press **⏮** to toggle between **Individual Timer Off** and **Individual Timer On**.
3. Press **END** to exit, or scroll to other features.

### *Setting the One-Minute Audible Timer*

Activate this feature to hear an audible beep 10 seconds before the end of every minute during a call. The party on the other end does not hear the beeps.

1. Follow the steps in "Getting to Call Timers" above to select **One Minute Timer**. You see **One Minute Timer Off** or **One Minute Timer On**.
2. Press **⏮** to toggle between **One Minute Timer Off** and **One Minute Timer On**.
3. Press **END** to exit, or scroll to other features.

**Tip:**  
*Activating the Individual Timer may reduce both standby and talk times.*

## Getting to Call Timers

1. Press **FCN**, then press **⏮** to enter the menu system.
2. Press **⏮** or **⏭** to scroll to **Timers**, and press **⏮** to select.
3. Press **⏮** or **⏭** to scroll to the following features, and press **⏮** to select.

### *Setting the Repeating Audible Timer*

You can set this timer to beep during your calls at an interval that you select—from 11-999 seconds. You will hear the beep 10 seconds before the end of each interval, but the party on the other end does not hear the beeps.

1. Follow the steps in “Getting to Call Timers” above to select Repeat Timer. You see Repeat Timer Off or Repeat Timer On.
2. Press **⏮** to toggle between Repeat Timer Off and Repeat Timer On.

The prompt to enter seconds appears **only** if you have turned the feature on. If you have turned it off, you see Repeat Timer Off.

3. If you turned the timer off, skip to step 5.

**or**

Enter the number of seconds you would like between audible beeps. You see Beep At YYY Secs.

4. Press **⏮** to set the timer. The phone confirms the setting by displaying Set At YYY Secs.
5. Press **END** to exit, or scroll to other features.



## Setting the Single Timer

Like the Repeating Timer, you can set the Single Timer to beep at a time that you select—from 11-999 seconds. It beeps once during each call, 10 seconds before the end of the interval. The party on the other end does not hear the beep.



1. Follow the steps in “Getting to Call Timers” on page 72 to select `Single Timer`. You see `Single Timer Off` or `Single Timer On`.
2. Press  to toggle between `Single Timer Off` and `Single Timer On`.

The prompt to enter seconds appears **only** if you have turned the feature on. If you have turned it on, you see `Single Timer Off`.

3. If you turned the timer off, skip to step 5.

**or**

Enter the number of seconds you would like between audible beeps. You see `Beep At YYY Secs`.

4. Press  to set the timer. The phone confirms the setting by displaying `Set At YYY Secs`.
5. Press  to exit, or scroll to other features.

# Adjusting Tone Controls

---

Use these features to select vibration mode, personalize your phone's ringer styles, or turn the ringer off.

In this chapter you will learn how to:

- select the type of Call Alert or Message Alert
- choose from nine different ringer styles
- silence the keypad
- silence the scratchpad



Follow these symbols as a guide for using the keys on the side of your phone:

**Press**  to scroll up. \_\_\_\_\_

**Press**  to select. \_\_\_\_\_

**Press**  to scroll down. \_\_\_\_\_



You can also use your phone's  and  keys to scroll through the menu system.

# Road Map for Tone Controls

To enter the menu system:

Press **FCN**, then press **0**.





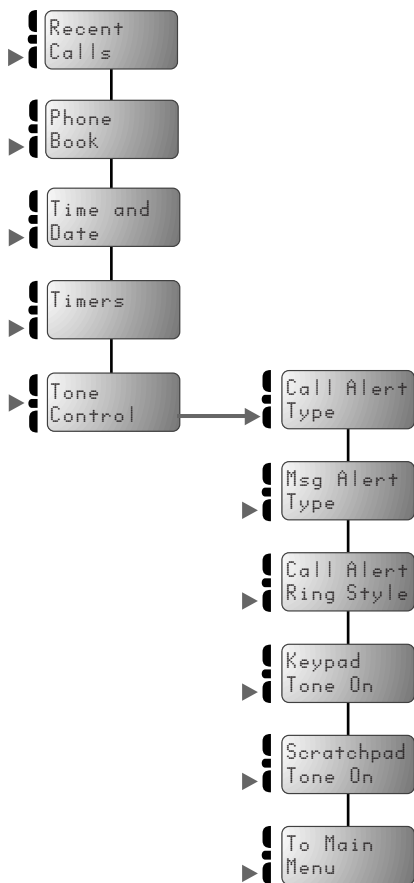

or

Press **FCN** **1 MENU**.

Start:



# Getting to Tone Controls

1. Press **FCN**, then **press**  to enter the menu system.
2. Press  or  to scroll to **Tone Control**, and **press**  to select.
3. Press  or  to scroll to the following features, and **press**  to select.

## Shortcut:

Press **FCN**  to toggle the VibraCall™ Alert function on and off.

## Selecting Call Alert Type

Using this feature, you can choose to be alerted to incoming calls using the vibrating ringer, the ringer, both, or neither. Ring Only is the default.

In particular, the VibraCall™ Alert vibrating alert is ideal for situations where ringing may not be appropriate, or in noisy places where you might not hear the ringer.



When both the ringer and vibrating alerts are selected, the phone alerts you by vibrating for three cycles and then ringing.





### Notes:



- Although you set your call alert type below, the selection is temporarily suppressed if Pager Mode is enabled. See “Activating Pager Mode” on page 92 for details.
- When your phone is connected to an external power supply and you receive an incoming call, your phone will ring, regardless of the call alert setting.

To select an alert type, complete the following steps:

1. Follow the steps in “Getting to Tone Controls” above to select Call Alert Type. Your phone displays your current alert type setting.

2. Press  or  to scroll through your choices:





Option	Icon (appears in idle display)
Ring Only	
Vibrate Only	
Vib then Ring	
Ringer Off Vib Off	

3. Press  when you reach the setting you want.
4. Press  to exit, or scroll to other features.

## Selecting Message Alert Type

Use this feature to select the alert type your phone uses for incoming voice mails and short messages. You can select the VibraCall® alert, beeping alert, or no alert.







The beep tones and vibrating patterns differ depending on whether the incoming message is marked urgent or normal. Your phone plays one beep for a normal message and three beeps for an urgent message.

1. Follow the steps in "Getting to Tone Controls" on page 76 to select **Msg Alert Type**.
2. Press  or  to scroll to **Messages Beep**, **Messages Vibrate**, or **Beep Off Vib Off**. **Messages Beep** is the default setting.
3. Press  when you reach the setting you want.
4. Press  to exit, or scroll to other features.

### Shortcut:

Press    to toggle among the Message Alert and Call Alert types.

## Getting to Tone Controls

1. Press **FCN**, then **press**  to enter the menu system.
2. Press  or  to scroll to **Tone Control**, and **press**  to select.
3. Press  or  to scroll to the following features, and **press**  to select.

### *Selecting a Ring Style*

Your phone lets you select any of nine different ring styles. After you choose a style, the phone give you a brief sample of the new ring style, or vibrates if you have selected the VibraCall™ Alert feature.

1. Follow the steps in “Getting to Tone Controls” above to select **Call Alert Ring Style**.
2. Press **1 MENU** through **9 WXYZ** to hear the different ring styles, or scroll through the ring styles. **Ring Style 1** is the default setting.
3. Press  when you reach the ring style you want.



Your phone displays **Ring Style X Set**, where *X* is the number of the style selected.

4. Press **END** to exit, or scroll to other features.

### *Turning Keypad Tones On and Off*



Keypad tones are the sounds you hear when you press any key on the phone. By default, keypad tones are turned on. If you want to be discreet, use this feature to silence the audio feedback from the keypad.

**Note:** The other party still hears tones when you use the keypad during a call.

1. Follow the steps in "Getting to Tone Controls" on page 78 to select Keypad Tone. You see Keypad Tone On or Keypad Tone Off.
2. Press  to toggle between Keypad Tone On and Keypad Tone Off.
3. Press  to exit, or scroll to other features.

## *Turning Scratchpad Tones On and Off*

Scratchpad tones are the tones that your phone sends to access automated calling systems like Voice Mail. By default, scratchpad tones are turned on. If you don't want your party to hear these sounds when you use the scratchpad, turn the scratchpad tones off.

1. Follow the steps in "Getting to Tone Controls" on page 78 to select Scratchpad Tone. You see Scratchpad Tone On or Scratchpad Tone Off.
2. Press  to toggle between Scratchpad Tone On and Scratchpad Tone Off.
3. Press  to exit, or scroll to other features.

**Note:** If you turned the scratchpad tones off but want to access a tone-activated system like Voice Mail, place the call, enter the numbers you need to transmit, then:

Press   to send the tones.

# Using Lock/Security Features

---

While you probably would not want to leave your phone unattended, your TDMA digital StarTAC™ phone has a number of built-in security features to prevent unauthorized use.

In this chapter you will learn how to:

- activate the Voice Privacy feature
- lock and unlock your phone
- place priority calls
- change your lock code
- restrict call placement and memory access
- reset or clear your phone's settings



Follow these symbols as a guide for using the keys on the side of your phone:

**Press**  to scroll up. \_\_\_\_\_

**Press**  to select. \_\_\_\_\_

**Press**  to scroll down. \_\_\_\_\_



You can also use your phone's  and  keys to scroll through the menu system.



# Road Map for Lock Security

To enter the menu system:

Press **FCN**, then press **0**.





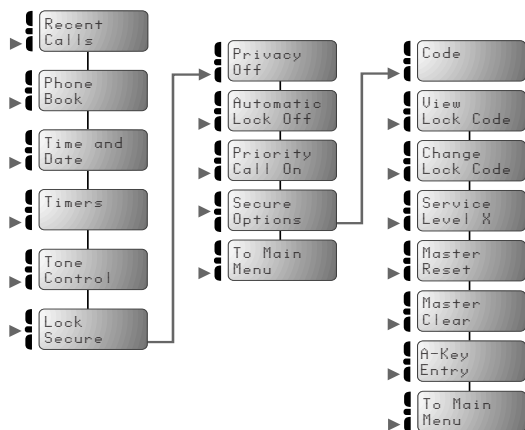

or

Press **FCN** **1 MENU**.

Start:



## Getting to Lock Security

1. Press **FCN**, then **press**  to enter the menu system.
2. Press  or  to scroll to **Lock Secure**, and **press**  to select.
3. Press  or  to scroll to the following features, and **press**  to select.

### *Activating Voice Privacy*

When you activate your phone's Voice Privacy feature, you request your cellular system to search for a Voice Privacy channel with each call. If no Voice Privacy channel is available (or your call is "handed off" to a cell where a Voice Privacy channel is not available), five short beeps alert you that the call is no longer private.

You must select the Voice Privacy feature before you make a call in order for that call to search for a Voice Privacy channel.

**Note:** This feature is not available in all markets. Contact your Service Provider for additional information about your service area.

To turn the Voice Privacy feature on or off:



1. Follow the steps in "Getting to Lock Security" above to select Voice Privacy. You see *Privacy Off* or *Privacy Preferred*.
2. Press  to toggle between *Privacy Off* and *Privacy Preferred*.
3. Press **END** to exit, or scroll to other features.

# Locking/Unlocking Your Phone

For your protection, you must enter the six-digit security code to access the features that your phone contains. The factory-programmed lock code for unlocking the phone is 123. The default security code is 000000. These may have been changed when your phone was activated.





## Locking Your Phone Automatically

When you turn this feature on, your phone automatically locks itself each time you turn it off.

1. Follow the steps in "Getting to Lock Security" on page 82 to select **Automatic Lock**. You see **Automatic Lock Off** or **Automatic Lock On**.
2. Press  to toggle between **Automatic Lock Off** and **Automatic Lock On**.
3. Press  to exit, or scroll to other features.

## Locking Your Phone Manually

You can lock your phone manually at any time to prevent unwanted use. Once you lock the phone, it remains locked whether it is powered on or off.

1. Press .
2. Press and hold  for at least one full second. You see **Lock?**.
3. Press  or  to lock. You see **Locked**.

## Unlocking Your Phone

To unlock your phone:

Once your phone is on, **enter your three-digit lock code** to unlock your phone. (See "Viewing the Lock Code" on page 85 and "Changing the Lock Code" on page 85 for more information on your lock code.)

### Shortcut:

Press , the Smart Button,  , and continue with step 2.

**Tip:** "LOCK" is printed on the  key, as a reminder.



**Tip:** If you forget your lock code, try pressing  the last three digits of your cellular phone number.

**Shortcut:**

Press , the Smart Button,  , and continue with step 2.

## Answering Calls While the Phone Is Locked

You can still receive calls when the phone is locked. To answer an incoming call:



1. Enter your three-digit lock code.
2. Press and hold , or press , to receive the call.

## Activating Priority Calling

Priority Call allows the Turbo Dial™ function to dial from memory location 01—even when the phone is locked. You can store an emergency number or the number of someone you would like to contact in case of emergency.

**Note:** Some cellular systems have their own emergency numbers and deny access to emergency numbers like 911 (not available in some areas). Check with your Service Provider for more information.

By default, Priority Call is activated. To turn it off or to switch it back on, complete the following steps:

1. Follow the steps in “Getting to Lock Security” on page 82 to select Priority Call. You see Priority Call Off or Priority Call On.
2. Press  to toggle between Priority Call Off and Priority Call On.
3. Press  to exit, or scroll to other features.

## Getting to Secure Options

1. Press **FCN**, then press **↵** to enter the menu system.
2. Press **⬅** or **➡** to scroll to **Lock Secure**, and press **↵** to select.
3. Press **⬅** or **➡** to scroll to the **Secure Options** submenu, and press **↵** to select.
4. Enter your **six-digit security code**, scroll to the following features, and press **↵** to select.

### Viewing the Lock Code

To display the active three-digit lock code:

1. Follow the steps in "Getting to Secure Options" above to select **View Lock Code**. You will see **View Lock Code**.
2. Press **↵** to display your three-digit lock code. The code appears for a few seconds.
3. Press **END** to exit, or scroll to other features.

### Changing the Lock Code

To change your three-digit lock code:



1. Follow the steps in "Getting to Secure Options" above to select **Change Lock Code**. You see **Enter Code —**.
2. Enter the new three-digit code. You see **Changed To XXX**.
3. Press **END** to exit, or scroll to other features.

**Note:** If you try to change your lock code to 911 or the first three digits of an emergency number, you will see **Code Invalid**, and the code you entered **will not** be accepted. You will return to step 1 above.

# Restricting Call Placement

You can restrict call placement or hide memory information when loaning your phone to others.

## Selecting a Service Level

1. Follow the steps in "Getting to Secure Options" on page 85 to select *Service Level*. The phone displays your current service level. Refer to the chart on the next page.
2. Press  or  to scroll through the service level settings, and press  to select the service level you want.

If you select Level 7, the phone prompts you for the range of memory locations you want to remain active. You see *Range 1---*.

Enter the range of digits memory locations from which calls are allowed. The phone confirms the allowed range, and you see *1-XX Allowed*.

3. Press  to exit, or scroll to other features.

## Service Level Settings

Your phone's eight service levels offer different combinations of access privileges and restriction.

**Note:** Caller Line ID is an optional network and subscription feature that is not available in all areas.

Level	Description	Display
1	<ul style="list-style-type: none"><li>• Calls can be placed from memory locations 1-10 only.</li><li>• No dialing from keypad</li><li>• No memory edit or storage</li><li>• No access to name directory</li><li>• No access to last number dialed</li></ul>	<i>1 Memory 1-10</i>

Level	Description	Display
2	<ul style="list-style-type: none"> <li>• Calls can be placed from all memory locations.</li> <li>• No dialing from keypad</li> <li>• No memory edit or storage</li> <li>• No access to Caller Line ID stack or Last Number Dialed</li> </ul>	2 Memory Only
3	<ul style="list-style-type: none"> <li>• Calls can be placed manually from the keypad only.</li> <li>• No access to memory information</li> <li>• No memory edit or storage</li> <li>• No access to Caller Line ID stack or Last Number Dialed</li> </ul>	3 Keypad Only
4	Standard setting, no restrictions	4 Standard Setting
5	Seven-digit (local) dialing only	5 Local Only
6	<ul style="list-style-type: none"> <li>• Calls can be placed from the keypad and from memory.</li> <li>• No edit or memory storage to memory locations 1-10</li> </ul>	6 No Store 1-10
7	<ul style="list-style-type: none"> <li>• Calls can be placed from a selected memory range only.</li> <li>• Memory edit and storage allowed with the selected range.</li> <li>• No access to name directory</li> </ul>	7 Allow Range
8	No edit, storage, or recall from memory locations 1-9	8 Hide Turbo

## Getting to Secure Options

1. Press **FCN**, then press **⏏** to enter the menu system.
2. Press **⏏** or **⏏** to scroll to **Lock Secure**, and press **⏏** to select.
3. Press **⏏** or **⏏** to scroll to the **Secure Options** submenu, and press **⏏** to select.
4. Enter your **six-digit security code**, scroll to the following features, and press **⏏** to select.

### *Resetting All Options*

Use the Master Reset feature to reset all user-selectable options back to their original factory settings.

**Note:** Once you select this feature, the reset process cannot be canceled or reversed.

1. Follow the steps in “Getting to Secure Options” above to select **Master Reset**.
2. Press **⏏** if you want to reset all your phone’s options back to their factory settings. You see **Standard Setting**.

**or**

Press **END** to exit the menu if you do not want to reset your phone’s options.

3. Press **END** to exit, or scroll to other features.



## Clearing All Stored Information

If you want to start over, use Master Clear to reset all user-selectable options, clear the resettable timer, and erase all Phone Book information.

**Note:** Once you select this feature, the process cannot be canceled or reversed.

1. Follow the steps in "Getting to Secure Options" on page 88 to select **Master Clear**.
2. Press **0** to clear the memory and reset all your phone's options back to their factory settings. You will see **Busy**. (This takes a few seconds.)

**or**

Press **END** to exit the menu if you do not want to reset your phone's options.

3. Press **END** to exit, or scroll to other features.

## A-Key Entry

This menu item is locked and can only be used when instructed by your Service Provider.

# Customizing Phone Options

---

The Phone Options menu lets you customize the way your phone sends and receives calls.

You can personalize your phone's settings, view information about the phone, and choose from a number of convenient features.

In this chapter you will learn how to:

- activate pager mode
- switch between analog or digital mode
- view your own phone number
- switch cellular phone numbers
- review your phone's feature settings
- select features for vehicular use
- conserve battery power
- display your system identification
- select a language



Follow these symbols as a guide for using the keys on the side of your phone:

**Press**  to scroll up. \_\_\_\_\_

**Press**  to select. \_\_\_\_\_

**Press**  to scroll down. \_\_\_\_\_



You can also use your phone's  and  keys to scroll through the menu system.

# Road Map for Phone Options

To enter the menu system:

Press **FCN**, then press **0**.





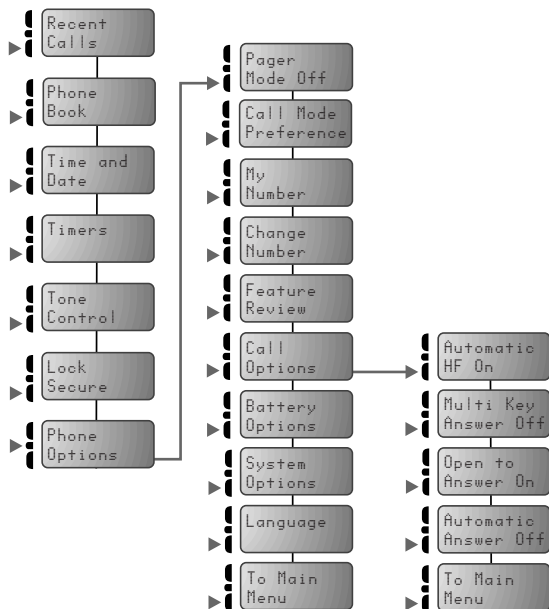

or



Press **FCN** **1 MENU**.

Start:



# Getting to Phone Options

1. Press **FCN**, then **press**  to enter the menu system.
2. Press  or  to scroll to **Phone Options**, and **press**  to select.
3. Press  or  to scroll to the following features



**Tip:** When *Pager Mode is active*, **FCN**  *only toggles the Message Alert Type settings.* **FCN**  *has no effect on the Call Alert Type settings.*

## Activating Pager Mode

When Pager Mode is activated, the phone simulates a pager. Pager Mode suppresses incoming call alerts but leaves message alerts active. The following conditions occur:





- Voice call alerts are suppressed.
- Message alerts are allowed.
- The Open to Answer function is turned off.
- The Automatic Answer function is turned off.
- The Call Alert Type, Open to Answer, and Automatic Answer menus cannot be accessed.

By default, Pager Mode is turned off. Complete the following steps to turn Pager Mode on and off.

1. Follow the steps in “Getting to Phone Options” above to select *Pager Mode on/off*. Your phone displays your current Pager Mode setting.
2. Press  to toggle between Pager Mode on and off.
3. Press **END**  to exit, or scroll to other features.





# Selecting Preferred Call Mode

You can assign either a digital or analog channel to your phone, based on system channel availability.

1. Follow "Getting to Phone Options" on page 92 to select Call Mode Preference.
2. Press  or  to scroll through Digital Voice Pref, Analog Voice Only, and Digital Voice Only.
3. Press  to make your selection.
4. Press  to exit, or scroll to other features.

## Notes:

- This is a network- and subscription-dependent feature that is not available in all areas. Contact your Service Provider for more information.
- When powered on, your phone searches for a digital channel. If no digital channel is available, the phone selects an analog channel.
- When you select Analog Voice Only, your phone remains in digital mode until you make a call (if a digital channel is available). The Analog Voice Only setting then remains active until you change to another setting or until you turn the phone off and back on.
- If you select Analog Voice Only or Digital Voice Only, you will not be able to make a call if the selected system is not available.

**Tip:** Press   to switch from digital to analog mode during a call. (You cannot switch from analog to digital mode.) Pressing   does not switch modes if your selected call mode is Analog Voice Only or Digital Voice Only.

## Getting to Phone Options

1. Press **FCN**, then press **⏏** to enter the menu system.
2. Press **⏏** or **⏏** to scroll to **Phone Options**, and press **⏏** to select.
3. Press **⏏** or **⏏** to scroll to the following features, and press **⏏** to select.

### Shortcut:

Press **RCL** **#** **▶** for a quick look at your phone number.

## Viewing Your Own Number

Use this feature to view your phone's currently active phone number. If you have more than one phone number, you can change the active number with the Change Number feature in the Phone Options menu.)

1. Follow the steps in "Getting to Phone Options" above to select **My Number**.
2. Press **⏏** to view your own phone number.

Your active phone number appears on the screen. After six seconds, the phone returns to step 1.

3. Press **END** to exit, or scroll to other features.



## Switching Between Numbers

**Note:** This option is not available in all areas. If unavailable, please contact your Service Provider.

Your phone can operate on two different home systems. If you travel often, you can have your phone programmed with two cellular numbers to reduce roaming. This feature allows you to change your active number to the one appropriate for the area you are in.

When your phone has two numbers, both are designated as your home system but only one number can be active at any given time. Calls are placed and received by the currently active number only. Each time you turn your phone ON, you'll see a message in the display that indicates which phone number and home system are currently active.





To switch your phone number:

1. Follow the steps in "Getting to Phone Options" on page 94 to select *Change Number*. The active phone number appears in the display (for example, 5155551515).
2. Press  to switch to your other phone number (for example, 7085551212).
3. Press  to confirm the new setting.
4. Press  to exit, or scroll to other features.

## *Reviewing Feature Settings*

Use this feature to review the changes you've made to feature settings.

**Note:** While scrolling through Feature Review, you can only review settings. You cannot change them.

1. Follow the steps in "Getting to Phone Options" on page 94 to select *Feature Review*.
2. Press  or , or press  or , to scroll through features you changed from their default settings.

If all of the features are set to the factory standard settings, the your phone displays *Standard Setting*.

3. Press  to exit the menu.

## Getting to Call Options

1. Press **FCN**, then press **↵** to enter the menu system.
2. Press **↵** or **⏪** to scroll to **Phone Options**, and press **↵** to select.
3. Press **↵** or **⏪** to scroll to the **Call Options** submenu, and press **↵** to select.
4. Press **↵** or **⏪** to scroll to the following features.

### *Activating Automatic Hands-Free*

Turn this feature on when you are using Hands-Free vehicular accessories.



**Note:** The use of wireless telephones and their accessories (devices) may be prohibited or restricted in certain areas. Always obey the laws and regulations on the use of these devices.



To find out more about accessories for your car, refer to "Accessory Options" on page 133.

1. Follow the steps in "Getting to Call Options" above to scroll to **Automatic HF**. You see **Automatic HF On** or **Automatic HF Off**.
2. Press **↵** to toggle between **Automatic HF On** and **Automatic HF Off**.
3. Press **END** to exit, or scroll to other features.





# Activating Multiple Key Answer

Turn on the Multiple Key Answer feature to answer calls by pressing the Smart Button, any key on the upper keypad  - , or the upper and lower volume keys.

1. Follow the steps in "Getting to Call Options" on page 96 to scroll to *Mult+ Key Answer*. You see *Mult+ Key Answer On* or *Mult+ Key Answer Off*.
2. Press  to toggle between *Mult+ Key Answer On* and *Mult+ Key Answer Off*.
3. Press  to exit, or scroll to other features.

# Deactivating Open to Answer

The Open to Answer feature allows you to set whether or not your phone automatically answers when opened. With Open to Answer set to off, you can open the phone to see the message in the display and then answer by pressing  or .

## Notes:

- To view Caller ID information prior to answering a call, you must turn off the Open to Answer feature.
- You cannot access the Open to Answer setting while the Pager Mode feature is active.

To toggle the Open to Answer feature, complete the following steps:

1. Follow the steps in "Getting to Call Options" on page 96 to scroll to *Open to Answer*. You see *Open to Answer On* or *Open to Answer Off*.

2. Press  to toggle between Open to Answer On and Open to Answer Off.



**Note:** The Open to Answer function cannot be accessed when in Pager Mode.

3. Press  to exit, or scroll to other features.

## Activating Automatic Answer







Turn Auto Answer on to have your phone automatically answer incoming calls after two rings.

**Note:** Auto Answer does not work if the keypad cover is closed or if Pager Mode is activated. However, the Auto Answer will work with a *headset* while the keypad cover is closed.

1. Follow the steps in “Getting to Call Options” on page 96 to scroll to Automatic Answer. You see Automatic Answer On or Automatic Answer Off.
2. Press  to toggle between Automatic Answer On and Automatic Answer Off.
3. Press  to exit, or scroll to other features.

**Tip:** If the ringer and VibriCall™ alert are off, the phone answers without ringing or vibrating.

## Getting to Phone Options

1. Press **FCN**, then **press**  to enter the menu system.
2. Press  or  to scroll to **Phone Options**, and **press**  to select.
3. Press  or  to scroll to the following features, and **press**  to select.

### Selecting Battery Options— Status Light

This feature enables you to turn off the Power/Status Indicator. Turn this mode off to increase talk or standby times.

1. Follow the steps in “Getting to Phone Options” above to select the **Battery Options** sub-menu. You see **Status Light On** or **Status Light Off**.
2. Press  to toggle between **Status Light On** and **Status Light Off**.
3. Press **END** to exit, or scroll to other features.



### Displaying System Identification

This feature shows the System ID number that identifies the cellular system your phone is currently accessing.

1. Follow the steps in “Getting to Phone Options” above to enter the **System Options** sub-menu. You see **Display SID**.
2. Press  to view the System ID number. After six seconds, the phone goes back to step 2.
3. Press **END** to exit, or scroll to other features.

## Selecting a Language

This feature enables you to select the language in which your phone displays prompts and messages.

1. Follow the steps in "Getting to Phone Options" on page 99 to select the Language sub-menu.
2. Press  to scroll through the language options.
3. Press  to select the language setting you want.
4. Press  to exit, or scroll to other features.

# Selecting a Network

**Note:** This is an optional network- and subscription-dependent feature that is not available in all areas.



The Network Selection menu lets you decide which network your phone will use.

In this chapter you will learn how to:

- perform a manual search for a network
- select a non-public network
- select a public network
- specify an automatic network search
- view all non-public networks

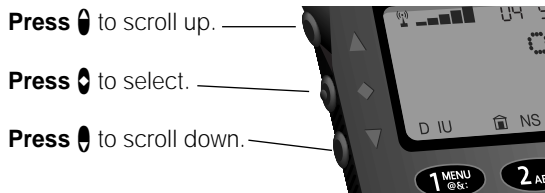
Follow these symbols as a guide for using the keys on the side of your phone:



You can also use your phone's  and  keys to scroll through the menu system.

# Road Map for Selecting a Network

To enter the menu system:

Press **FCN**, then press **0**.





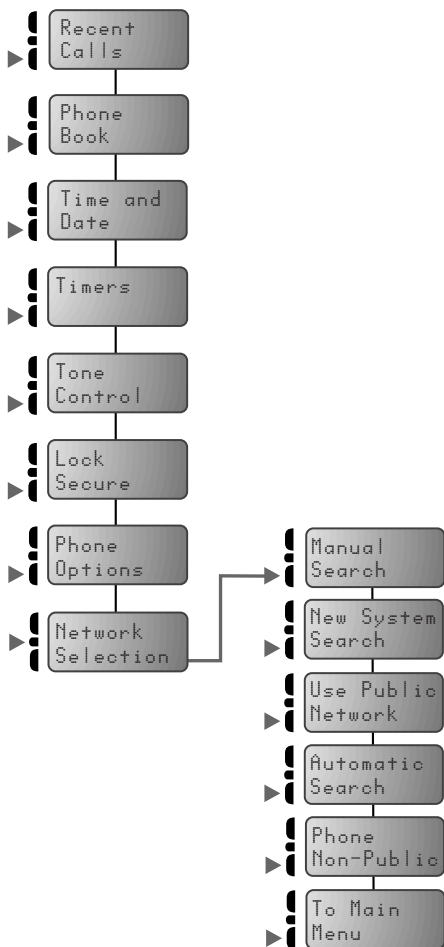

or

Press **FCN** **1 MENU**.

Start:



## Getting to Network Selection

1. Press **FCN**, then **press**  to enter the menu system.
2. Press  or  to scroll to **Network Selection**, and **press**  to select.
3. Press  or  to scroll to the following features.

### *Performing a Manual Network Search*



To perform a manual search for a network:

1. Follow "Getting to Network Selection" above to scroll to *Manual Search*, and press  to activate a search.

Your phone begins to search for all available networks to which you have subscriptions, and displays the names of any networks it locates.

- If the phone is registered with a public network when you start the search, it displays the names of all non-public networks first.
- If the phone is registered with a public network when you start the search, it displays the names of all public networks first.

If the phone cannot locate an available network, it displays *Not Available*.

2. Press  or  to scroll through the list of available networks.
3. Press  to register with a displayed network.

If registration is successful, your phone displays a confirmation message from the network.

**Note:** The phone is registered with the selected network until you place or receive a call or until you turn the phone off and on.

If registration is not successful, you see Not Available. (Registration can fail if you travel outside the network range after you locate the network but before you attempt to register.) Press **END** to exit, and retry later.

## Selecting a New Network

To search for and select a new network:

1. Follow "Getting to Network Selection" above to scroll to New System Search, and press **OK** to activate a search.
2. Follow the appropriate instructions below:

If You See This Message:	Do the Following:
Search Done: [network ID]	<ul style="list-style-type: none"><li>• To search for the next best network, press <b>CLR</b>.</li><li>• When you see the desired network, go on to step 3.</li><li>• To cancel the search and exit the menu, press <b>END</b>.</li></ul>
Search All Bands?	<ul style="list-style-type: none"><li>• To continue searching for networks in another band, press <b>OK</b>.</li><li>• When you see the desired network, go on to step 3.</li><li>• To cancel the search and exit the menu, press <b>CLR</b>.</li></ul>
Not Available	Press <b>END</b> to exit, and retry the search later.
Non-Public Not Found	The phone returns to standby mode. Retry the search later.



3. Press **OK** to register with the displayed network.

If registration is successful, your phone displays a confirmation message from the network.

**Note:** The phone is registered with the selected network until you place or receive a phone call or until you turn the phone off and on.

If registration is not successful, your phone displays *Not Available*. (Registration can fail if you travel outside the network range after you locate the network but before you attempt to register.)

## Selecting a Public Network

To search for and select a public network:

Follow "Getting to Network Selection" on page 103 to scroll to *Use Public Network*, and press **OK** to activate a search.

If the phone finds a public network, it attempts to register. When registration is successful, your phone displays a confirmation message.

**Note:** The phone is registered with the selected network until you place or receive a phone call or until you turn the phone on and off.

If the phone does not find a public network, it displays *Public Not Found*.

Press **END** to exit, or scroll to other features.

To cancel a search, press **CLR** or **END**.

## *Specifying an Automatic Search*

To reset the phone to perform an automatic network search (rather than forcing the selection of a public or non-public network):

Follow "Getting to Network Selection" on page 103 to scroll to *Automatic Search*, and press  to select it.



## *Viewing All Non-Public Networks*

You can list up to fifteen non-public networks that your phone has located in previous searches.

To list non-public networks:

1. Follow "Getting to Network Selection" on page 103 to scroll to *View All Non-Public*, and press  to select it.

Your phone displays the first network in the list.

2. Press  or  to scroll through the entire list.
3. Press  to exit, or scroll to other features.

# Using the Message Center

The Message Center gives you easy access to both voice mail and your text messages. In this chapter you will learn how to:



- use voice mail
- use short messaging services (SMS) to send and receive text messages
- edit a phone number to access voice mail

## Notes:

- Voice mail and SMS are optional network and subscription-dependent features that are not available in all areas.
- Sending SMS messages to email addresses may not be supported by all networks and Service Providers.

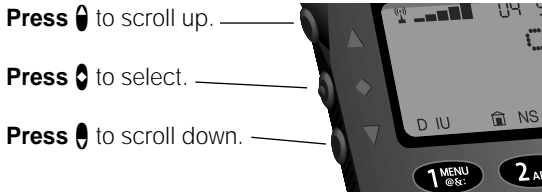
Follow these symbols as a guide for using the keys on the side of your phone:





You can also use your phone's  and  keys to scroll through the menu system.

# Road Map for Message Center

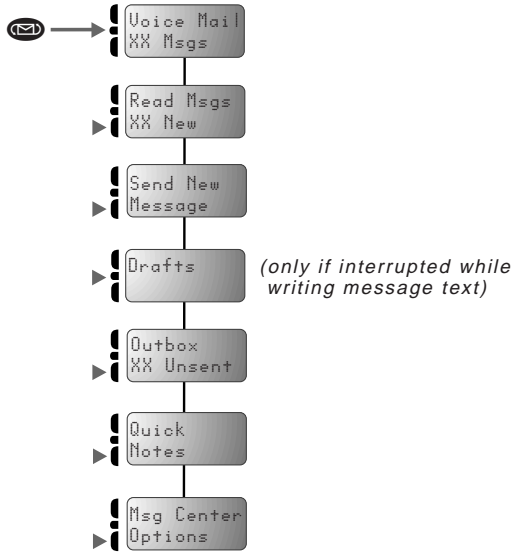
Start:



# Getting to Voice Mail

1. Press  to enter the Message Center.
2. Press  or  to scroll to **Voice Mail**.

## Voice Mail Alerts

This feature notifies you whenever a message is sent to your voice mail number, providing real-time information on messages waiting to be retrieved.

When a voice mail message is received:

- Voice Mail *XX* Msgs is displayed, where *XX* is the number of message you have waiting.
- The  icon appears.
- The phone beeps three times or vibrates one time for a message.

## Dialing Voice Mail

You can retrieve your voice mail messages in one of two ways.

### **From the Voice Mail Alert Screen**

When you receive a voice mail alert and Voice Mail *XX* Msgs appears, press  to dial your voice mail number.



Your phone automatically dials the access number for the voice mail center and displays Dialing *XXXXXX*, where *XXXXXX* is the access number.

### **From the Message Center**

Follow the steps in "Getting to Voice Mail" above, and press  to dial your voice mail number.

Your phone automatically dials the access number for the voice mail center and displays Dialing *XXXXXX*, where *XXXXXX* is your access number.

## Getting to Read Messages

1. Press  to enter the Message Center.
2. Press  or  to scroll to **Read Msgs**.

You see **Read Msgs** *XX* New, where *XX* is the number of unread messages. The total number of messages stored, *YY* appears in the upper right of the display.

3. Press  to select **Read Msgs**.

### *Reading and Managing Text Messages*

If you subscribe to a Short Message Service (SMS), you may be able to receive alphanumeric messages on your phone, just like a pager. Contact your Service Provider for information about the availability of messaging in your area.

You can save from 1225 to 6125 message characters, depending on your phone model.

Your phone saves all incoming messages. When message memory is full, each new incoming message automatically replaces the oldest unlocked message.



### *How Your Phone Receives Message Alerts*



#### *New Message Alerts*

When your phone is on and receives a new text message, it alerts you in two different ways:

- Your phone displays **Text Msgs** *XX* New (where *XX* is the number of new messages).
- The message icon  appears.





## Reading Text Messages

1. Follow the steps in “Getting to Read Messages” on page 110.
  - If you have text messages, you see Read Msgs *XX* New, where *XX* is the number of unread messages. The total number of messages stored is displayed in the upper right corner.
  - If you have no messages, you see Read Msgs 00 New, and 00 is displayed in the upper right corner.
  - If the Message Center is full, you see Msg Memory Full and then the list of message headers.
2. Press  or  to scroll through the list of message headers. Messages are numbered from oldest to newest. (The oldest is number 1.) Each header includes:
  - the message number
  - the first two lines of the message text
  - a status icon:
    - If the message is locked, you see the lock icon.
    - If the message has been read, you see a check mark.
    - If the message is unread and is normal priority, no status icon is displayed.
    - If the message is unread and its priority is Urgent or Emergency, you see . (The status icon changes to a check mark when the message is read.)

3. Press  to select and view the message text, starting on the top line.
4. Press  or  to scroll through the message text. After you scroll through the entire message, you return to the list of message headers.

**or**

Select a message option:

- a. Press  to select **Options**.
- b. Press  or  to scroll through the **Options** menu, and press  to select one of the following:
  - **Reply to Message**—See “Message Options—Replying to a Message” on page 113.
  - **Forward Message**—See “Message Options—Forwarding a Message” on page 114.
  - **Message Details**—See “Message Options—Viewing Message Details” on page 115.

To exit the **Options** menu and return to the message text, scroll to **Return To Message** and press  to select, or press **END** at any time.

5. Press **END** to exit the Message Center, or scroll to other features.



## Message Options—Replying to a Message

To reply to a message from the messages Options menu:

1. Scroll to **Reply to Message**, and press **Enter** to select.
2. Press **Enter** to confirm the reply address.

**or**

Edit the reply address, and press **Enter** when finished.

3. Enter the message text and press **Enter**. (See “How to Enter Text” on page 36.)
4. Press **Left** or **Right** to scroll to **Normal**, **Urgent**, or **Emergency** priority.
5. Press **Enter** to select the priority and send the message.

Your phone:

- sends the message and briefly displays **Sending Message**
- saves a copy of the message to the **Outbox**
- exits the Message Center

## Message Options—Forwarding a Message

To forward a message from the messages Options menu:

1. Press **Left Arrow** or **Right Arrow** to scroll to Forward Message, and then press **Enter** to select.
2. Press **Left Arrow** or **Right Arrow** to scroll to Send to a Mobile or Send as E-Mail, and press **Enter** to select.
3. Enter the phone number or email address, and press **Enter** when finished.

To send the message to a number or email address stored in your Phone Book, press **Enter** to open the Phone Book, scroll to an entry, and press **Enter** to select it.

4. Press **Enter** to send the message text without changes.

**or**



Edit the message text, as desired:

- a. Press **Left Arrow** or **Right Arrow** to scroll through message text. Press **CLR** to delete one letter at a time. Press and hold **CLR** to delete the entire message. (See "How to Enter Text" on page 36 for more information on entering characters.)
  - b. When you finish editing message text, press **Enter**.
5. Press **Left Arrow** or **Right Arrow** to scroll to Normal, Urgent, or Emergency priority.
  6. Press **Enter** to select the priority and send the message.

Your phone:

- sends the message and briefly displays Sending Message
- saves a copy of the message to the Outbox
- exits the Message Center

## Message Options—Viewing Message Details

1. Press  or  to scroll to **Message Details**, and press  to select.



Your phone displays **Sent:**, followed by the time and date stamp. This is the time and date the message was sent to the network (not the time and date that the message was received).

2. Press  to display the number or email address from which the message was sent.

If the message was sent from another phone, you see **Call Back:** followed by the Call Back Number. If the Call Back Number matches a number in your Phone Book, the name is displayed. If there are multiple numbers in the message, continue scrolling to view them.

**or**

If the message came from an email address, you see **From:**, followed by the address.

3. To store the Call Back number or originating email address:
  - a. When the Call Back number or email address you want to store is displayed, press  to begin storing.
  - b. Enter a name to identify the phone number. (See "How to Enter Text" on page 36.)
  - c. Press  when you finish entering the name.

You see **Number:** *XXXX*, where *XXXX* is the Call Back number or email address.

d. Edit the number or email address, if desired. Press **CLR** to delete one character at a time. Press and hold **CLR** to delete the entire number or email address.

e. Press **↵** when you finish editing the number or email address.

You see `Location _`.

f. Enter the two-digit memory location where you want the sequence stored.

**or**

Press **←\*** to store the sequence in the first available location.

**or**

Enter the first digit of the memory location, then press **←\*** to store the sequence in the first available location beginning with that digit.

Your phone displays `Stored at XX` (where `XX` is the memory location) and then returns to message details.

4. Press **↵** to return to the message text.
5. Press **END** to exit, or scroll to other messages.

## Locking and Unlocking a Message

You can lock important messages to ensure their safekeeping for later review. A locked message cannot be deleted until the message is unlocked.

When viewing a message, press **FCN** **5 LOCK** to toggle between locked and unlocked.

**Msg Locked** is displayed when a message is locked.

**Note:** If your message memory is full and a new message is received, the oldest unlocked message that has been read is deleted.

If message memory is full and all messages are locked:

- You cannot receive new messages.
- When you access message headers and then attempt to read a message, you see **Inbox full**.
- The  indicator flashes.

## Clearing Messages

**Note:** You must unlock a locked message before you can clear it. For more information, see “Locking and Unlocking a Message” on page 117.

### Clearing the Current Message

1. Press **CLR** when the message you want to delete is on the display.

You see **Delete XXX?**, where **XXX** is the number of the message to be cleared.

2. Press **0** to delete the message.

You see **Msg XXX Deleted**, where **XXX** is the number of the deleted message.

**or**

Press **END** or any other key if you do not wish to delete the message.

3. Press **END** to exit, or scroll to other messages.

## ***Clearing All Messages***

To erase all the messages in a folder at once:

1. While in the folder, press and hold **CLR**.

You see `Delete All?`.

2. Press **Y** or **STO** to verify that you want all the messages cleared.

**or**

Press **END** if you decide not to clear all the messages. You return to the Message Center.

3. Press **END** to exit from the Message Center.

If all messages have been cleared and no locked messages remain, `Msg Center Empty` is displayed.

## ***Initiating a Call Back***

While you are reading a text message, you can call back a number embedded in the message.





1. While viewing message headers, reading message text, or viewing message options, press **SEND** to initiate a Call Back, if the originating phone number or a Call Back number was included in the message.

2. Press **Y** to dial the number shown.

**or**

If the text message includes more than one Call Back number, or if there is a Call Back number and an embedded phone number, the phone displays a list of the numbers. Press **Y** or **Y** to scroll to the number you want to call, then press **Y** to dial the number shown.

## Getting to Send New Message

1. Press  to enter the Message Center.
2. Press  or  to scroll to **Send New Message**, and press  to select it.





### *Sending Text Messages*



If you subscribe to a Short Message Service (SMS), you may be able to send alphanumeric messages from your TDMA digital StarTAC™ phone. Contact your Service Provider for information about the availability of messaging in your area.

### ***Sending a Message from the Message Center***

**Note:** Sending SMS messages to email addresses may not be supported by all networks and Service Providers.

To send a message from the Message Center:

1. Follow the steps in "Getting to Send New Message" above.
2. Press  or  to scroll to **Send to a Mobile** or **Send as E-Mail**, and press  to select.
3. Enter the phone number or email address, and press  when finished.







To send the message to a number or email address stored in your Phone Book, press  to open your Phone Book, scroll to an entry, and press  to select it.

**Tip:** When you reach the character limit of a message, the cursor stops scrolling and you are unable to enter more text.

4. Enter the message text. (See "How to Enter Text" on page 36.)

**or**

Select text from a message in the Quick Notes folder:

- a. Open the Quick Notes folder by pressing .
  - b. Scroll through the message headers and press  to select the message you want.
5. When you finish entering the message text, press .
  6. Press  or  to scroll to Normal, Urgent, or Emergency priority.
  7. Press  to select the priority and send the message.

Your phone:

- sends the message and briefly displays Sending Message
- saves a copy of the message to the Outbox
- exits the Message Center





## ***Sending a Message from the Phone Book***





To send a message from your Phone Book:

1. Enter the Phone Book, and select the entry to receive the message. (See "Managing the Phone Book" on page 49.)
2. Press  to enter the Message Center.

If the current phone book entry contains only a phone number or an attached email address, you see `Enter Msg:`.

**or**





If the current phone book entry has both a phone number and an attached email address, press  or  to scroll to `Send to a Mobile` or `Send as E-Mail`, and press  to select.

3. Enter a new text message. (See "How to Enter Text" on page 36.)
4. When you finish entering the message, press .
5. Press  or  to scroll to `Normal`, `Urgent`, or `Emergency` priority.
6. Press  to select the priority and send the message.

Your phone:

- sends the message and briefly displays `Sending Message`
- saves a copy of the message to the `Outbox`
- exits the Message Center



## Getting to Quick Notes

1. Press  to enter the Message Center.
2. Press  or  to scroll to **Quick Notes**, and press  to select it.







### *Sending, Creating, Editing, and Deleting Quick Notes*



Quick Notes are pre-written text messages that you can edit and send. You can also create or delete Quick Notes.

#### ***Sending Quick Notes***

1. Follow the steps in “Getting to Quick Notes” above.
2. Press  or  to scroll to **Send a Quick Note**, and press  to select it.

You see the Quick Note list.

3. Press  or  to scroll to the Quick Note text you want to send, and press  to select it.
4. Press  or  to select **Send to a Mobile** or **Send as E-Mail**, and press  to select it.
5. Enter the phone number or email address, and press  when finished.

To send the message to a number stored in your Phone Book, press  to open the Phone Book, scroll to an entry, then press  to select it,

6. Press  to send the message text without changes.

**or**

**Tip:** *You cannot select Send a Quick Note unless you have one created.*

Edit the message text, as desired:

- a. Press **◀\*** or **#▶** to scroll through message text. Press **CLR** to delete one digit at a time. Press and hold **CLR** to delete the entire message. (See “How to Enter Text” on page 36 for more information on entering text.)
  - b. When you finish editing message text, press **⏏**.
7. Press **⏏** or **⏏** to scroll to Normal, Urgent, or Emergency priority.
  8. Press **⏏** to select the priority and send the message.

Your phone:

- sends the message and briefly displays `Sending Message`
- saves a copy of the message to the Outbox
- exits the Message Center

## Creating Quick Notes

You can create Quick Notes that you can select and send later.









1. Follow the steps in “Getting to Quick Notes” on page 122.
2. Press **⏏** or **⏏** to scroll to `Create a Quick Note`, and press **⏏** to select it.

You see `Enter Msg:`.

If your Quick Notes folder is full, you see `QuickNotes Full` and cannot create another Quick Note until you first delete an existing one. (See “Deleting Quick Notes” on page 124.)



3. Enter the Quick Note text, and press **⏏** to store it. (For instructions on entering text with your keypad, refer to “How to Enter Text” on page 36.)

## Editing Quick Notes

1. Follow the steps in “Getting to Quick Notes” on page 122.
2. Press  or  to scroll to **Edit a Quick Note**, and press  to select it.  
  
Your phone displays the Quick Note list.
3. Press  or  to scroll to the Quick Note you want to edit, and press  to select it.
4. Edit the Quick Note text, and press  to store it. (For instructions on entering text with your keypad, refer to “How to Enter Text” on page 36.)
5. Press  to exit the **Change a Quick Note** menu.



## Deleting Quick Notes

To delete a single Quick Note:

1. Follow the steps in “Getting to Quick Notes” on page 122.
2. Press  or  to scroll to **Delete a Quick Note**, and press  to select it.

Your phone displays the Quick Note list.

**Note:** Any time you are viewing the Quick Notes list, you can delete all Quick Notes by pressing and holding .

3. Press  or  to scroll to the Quick Note you want to delete, and press  to select it.

You see **Delete XXX?**, where **XXX** is the number of the Quick Note you will delete.





4. Press  to delete the Quick Note.

**or**

Press  to exit without deleting the Quick Note.

5. Press  to exit the **Delete a Quick Note** menu.

## Getting to the Draft Folder

1. Press  to enter the Message Center.
2. Press  or  to scroll to **Drafts**, and press  to select it.

### *Reading and Sending Draft Messages*





If an incoming call or other event interrupts you while you are creating a message, your phone saves the message to the Draft folder.

The draft folder holds one message. This message is erased if you start another new message or turn off your phone.

To open and complete a draft message:

1. Follow the steps in “Getting to the Draft Folder” above. Your phone displays the draft message.
2. Complete and then send the message. (Refer to “Sending Text Messages” on page 119.)

## Getting to the Outbox

1. Press  to enter the Message Center.
2. Press  or  to scroll to **Outbox**, and press  to select it.

### *Reviewing Messages in Your Outbox*



All sent messages are saved in your Outbox. The Outbox contains:



- messages that have been successfully transmitted  
  
A check mark beside a message indicates that the message has been successfully transmitted.
- messages that are waiting to be transmitted
- messages for which transmission failed

The Outbox holds up to 6125 characters. When the Outbox is full and a new message is sent, the oldest message that was successfully transmitted is deleted to make room for the new message.

You can review the messages in your Outbox to see if a message has been sent or to retry transmission, if necessary.





To access the messages in your Outbox:



1. Follow the steps in “Getting to the Outbox” above.
2. Press  or  to scroll through the list of headers for messages in the Outbox. Each header includes:
  - the message number
  - the beginning of the message text
  - a check mark, if the message has been sent



3. Press  to select and view the message text, starting on the top line.
4. Press  or  to scroll through the message text. After you scroll through the entire message, you return to the list of message headers.

**or**

Select an Outbox option:

- a. Press  to select `Options`.
- b. Press  or  to scroll through the `Options` menu, and press  to select one of the following:
  - `Resend Message`—See “Outbox Options—Resending a Message” on page 128.
  - `Forward Message`—See “Outbox Options—Forwarding a Message” on page 129.
  - `Message Details`—See “Outbox Options—Viewing Message Details” on page 130.

To exit the `Options` menu and return to the message text, scroll to `Return to Message` and press  to select, or press  at any time.

5. Press  to exit the Outbox, or scroll to other message headers.
6. Press  to exit the Message Center.

## Outbox Options—Resending a Message

To resend a message from the Outbox Options menu:

1. Scroll to **Resend Message**, and press **OK** to select.
2. Press **Left** or **Right** to select **Send to a Mobile** or **Send as E-Mail**, and press **OK** to select it.
3. Edit the phone number or email address, if needed, and press **OK**.
4. Press **OK** to send the message text without changes.

**or**

Edit the message text, as desired:

- a. Press **Left** or **Right** to scroll through message text. Press **CLR** to delete one character at a time. Press and hold **CLR** to delete the entire message. (See "How to Enter Text" on page 36 for more information on entering text.)
  - b. When you finish editing message text, press **OK**.
5. Press **Left** or **Right** to scroll to **Normal**, **Urgent**, or **Emergency** priority.
  6. Press **OK** to select the priority and send the message.

Your phone:

- sends the message and briefly displays **Sending Message**
- saves a copy of the message to the **Outbox**
- exits the **Message Center**



## Outbox Options—Forwarding a Message

To forward a message from the Outbox Options menu:

1. Press **Left Arrow** or **Right Arrow** to scroll to Forward Message, and press **Enter** to select.
2. Press **Left Arrow** or **Right Arrow** to select Send to a Mobile or Send as E-Mail, and press **Enter** to select it.
3. Enter the phone number or email address, and press **Enter**.



To send the message to a number stored in your Phone Book, press **Enter** to open the Phone Book, scroll to an entry, and press **Enter** to select it.

4. Press **Enter** to send the message text without changes.

**or**

Edit the message text, as desired:



- a. Press **Left Arrow** or **Right Arrow** to scroll through message text. Press **CLR** to delete one digit at a time. Press and hold **CLR** to delete the entire message. (See “How to Enter Text” on page 36 for more information on entering characters.)
- b. When you finish editing message text, press **Enter**.

5. Press  or  to scroll to Normal, Urgent, or Emergency priority.
6. Press  to select the priority and send the message.



Your phone:

- sends the message and briefly displays `Sending Message`
- saves a copy of the message to the Outbox
- exits the Message Center

### ***Outbox Options—Viewing Message Details***

1. Press  or  to scroll to `Message Details`, and press  to select.

Your phone displays `Sent:`, followed by the time and date stamp and the number or email address to which the message was sent.

2. Press  to return to the message text.
3. Press  to exit, or scroll to other messages.

## Deleting Unsent Messages from the Outbox

You can cancel any unsent messages that are still in the Outbox:

1. Press **CLR** when the message you want to delete is displayed.

You see `Delete entry?`.

2. Press **0** to clear the message.

You see `Message XX Deleted`, where *XX* is the number of the deleted message.

**or**







Press **END** or any other key if you do not wish to clear the message.

3. Press **END** to exit, or scroll to other features.

If you delete a message in this list, your phone does not send it.

**Note:** If the Outbox is full of unsent messages, you must delete one before you can send any more messages.

# Getting to Message Center Options

1. Press  to enter the Message Center.
2. Press  or  to scroll to **Msg Center Options**, and press  to select.
3. Press  or  to scroll to the following features.

**Tip:** When you enter the voice mail number, remember to add pauses at appropriate intervals so you can enter required information (such as password) when prompted. See “Entering a Pause in a Number” on page 53.



## Editing the Voice Mail Number

This feature allows you to save your voice mail access number.

**Note:** When you receive your phone, the default voice mail number is your phone number.

1. Follow the steps in “Getting to Message Center Options” above.
2. Press  to select `Set Voice Mail No.`
3. Enter your voice mail number.

The digits appear as you enter them.

Press  to delete one digit at a time. Press and hold  to delete the entire number.

4. Press  or .

A message confirms that your number has been saved.

**Note:** If you subscribe to a system that provides a shortcut number for voice mail, enter the complete number—not the shortcut number.

5. Press  to exit, or scroll to other features.

# Reference Information

---

## Accessory Options

An exciting line of Motorola TDMA digital StarTAC™ accessories, now smaller and lighter than ever, can enhance and personalize your cellular experience.

### Batteries



If your cellular phone is quickly becoming your companion, an optional auxiliary battery gives your phone a boost. Auxiliary batteries attach to the back of your phone and provide extra power to supplement your main battery.

### Vehicle Power Adapter



With the vehicle power adapter, you can power your phone and charge its battery directly from your vehicle's power adapter plug. In some vehicles, the engine must be running in order for the power adapter plug to operate.

## ***Desktop Charger (AC Adapter required)***



The desktop charger is designed for optimal performance and compatibility with Motorola's new generation of cellular telephones. The desktop charger's pocket can charge batteries while they are attached to or separate from your phone. Now it is easy to rotate batteries and always have a charged spare.

## ***Holster***



Your TDMA digital StarTAC™ phone is so small and light, it is positively wearable. Slip it in and clip it on—for the ultimate in high-tech fashion.

### **Notes:**

- The holster is designed for your convenience and is not meant to secure your phone under all circumstances.
- For body-worn use, keep the antenna at least one inch from your body when transmitting.

## ***Headset***



The convenient headset provides both an earphone and microphone in one small piece for simple hands-free and private telephone conversations. The headset plugs directly into the jack on the top of your phone, so that you can wear your phone and move freely. Place the foam cover on the earpiece for a more comfortable fit.

## ***Hands-Free Vehicle Kit***

The optional Hands-Free Kit gives you the convenience of hands-free, speaker phone operation while in your car. Full duplex operation lets you simultaneously talk and listen, so both parties can interrupt each other for a normal sounding conversation.

The Hands-Free Kit automatically powers your phone and charges its battery (even when your car's engine is turned off). The Hands-Free Kit also includes a required external antenna that can improve your signal reception and boost performance.

**Note:** The use of wireless telephones and their accessories (devices) may be prohibited or restricted in certain areas. Always obey the laws and regulations on the use of these devices.

## ***Accessory Limited Warranty Information***

We recommend that you use Motorola original batteries and accessories. Under its limited cellular telephone warranty, Motorola specifically disclaims any responsibility for damage caused by the use of portable cellular telephone accessories not manufactured by Motorola.

For details on the complete line of Motorola cellular accessories, see your dealer or visit our Web site at <http://www.mot.com/>.

# Troubleshooting

Question	Answer
<b>I pressed the power button, but nothing happened. What's wrong with my phone?</b>	Make sure that you press and hold the power button until the display appears and you hear an audible alert. If nothing still happens, then check that you have installed a battery and that the battery is charged. For more information about batteries and charging see the sections on batteries starting with "Installing and Removing Batteries" on page 18.
<b>My battery didn't last as long as I expected. What can I do to extend battery life?</b>	<p>Your battery's "standby-time" is a relative measurement of the battery's capacity. The more you talk on the phone, the less standby time you have, and vice versa. To get the most from your battery, allow it to charge fully. To charge the battery to 100% of its capacity, leave it in the charger for an extra hour after the charger's light turns green.</p> <p>You can also turn on the Power Save Mode feature to extend battery life. However, the LED Power/Status Indicator does not light when this feature is activated.</p> <p>Certain features demand power from your battery and reduce battery life. If you have selected the Automatic Display of Individual Call Timer feature, the display uses battery power to remain active during each call. Turn this feature off to conserve battery energy. (See "Displaying the Individual Timer Automatically" on page 71 for more information on this feature.)</p> <p>Make sure that you are calling in Digital mode.</p> <p>Make sure that you are using batteries that are compatible with your phone.</p> <p>Exposing your battery to extreme temperatures—below -10°C (14°F) or above 45°C (113°F)—can shorten battery life. Batteries are especially sensitive to high temperature extremes. As a good rule, always take your phone with you when you leave your car.</p>
<b>The display says, "Locked." How do I unlock my phone?</b>	Enter the last three digits of your cellular number. If that doesn't work, use the factory preset lock code: 123. If all else fails, call your Service Provider (the company that sends you your monthly cellular bill) for assistance. (See "Locking/Unlocking Your Phone" on page 83 for more information on Security Features.)



Question	Answer
<p><b>I tried to place a call and received a fast busy signal.</b></p>	<p>This sound means that the cellular system did not process your call. For example, the cellular system may be overloaded with call attempts. To redial the number, press <b>SEND</b> before ending your call attempt, or press <b>END</b> and try the call again later. (See "Redialing a Number Automatically" on page 30 for more information on redialing.)</p>
<p><b>I tried to place a call and received an alternating high/low tone.</b></p>	<p>This sound means your call did not reach the cellular system. You may have dialed the number too soon after turning the phone on. Wait until the "NS" light stops blinking before placing a call.</p> <p>An alternating tone may also indicate that your phone's signal is blocked. Make sure you're clear of any obstructions such as bridges, parking garages, or tall buildings.</p>
<p><b>I tried to listen to my Voice Mail (or use a paging service, a calling card, etc.) but nothing happened.</b></p>	<p>You have probably turned off the Scratchpad tones. Place your call, enter the access numbers when prompted by the recording, then press <b>RCL</b> <b>SEND</b>. To avoid this problem in the future, follow the directions "Turning Scratchpad Tones On and Off" on page 79 to turn the Scratchpad tones on.</p>
<p><b>My phone was stolen. What should I report and to whom?</b></p>	<p>Report a stolen phone to the police and to your Service Provider (the company that sends you your monthly cellular service bills).</p>
<p><b>I tried to place a calling card call using the internal Phone Book, but it didn't work.</b></p>	<p>You may have turned off your Scratchpad tones. Follow the directions in "Turning Scratchpad Tones On and Off" on page 79 to turn the Scratchpad tones on.</p> <p>Check that you stored your calling card information in the correct order, and make sure the groups of numbers are separated by pauses. The easiest way to correct the sequence may be to start from scratch. Follow the instructions on "Storing Calling Card Information" on page 55, enter your calling card information again, and store it in the same memory location as your previous attempt.</p> <p>Also keep in mind that when using your calling card, you must enter the number you are calling with the area code, but without the initial "1." Check with your long distance carrier for details on using your calling card.</p>

# Glossary

---

## A

**AC adapter** An accessory device that allows you to power your phone and charge any attached batteries from a wall outlet.

**AMPS (Advanced Mobile Phone System)** A cellular technology that operates on 832 channels.

**accessory connector port** A socket on the bottom of the phone where you can attach accessories such as an AC adapter, battery charger, vehicle power adapter, or optional accessories.

**antenna** The device attached to your phone that sends and receives cellular signals.

**Auto Answer** When you activate this feature, your phone automatically answers after two rings. See “Selecting Battery Options—Status Light” on page 99.

**Automatic Redial** When your cellular network cannot handle your call, this feature enables your phone to automatically redial for the next four minutes. See “Redialing a Number Automatically” on page 30.

## C

**Caller Line ID** A network/subscription dependent service that allows you to view information on incoming calls before answering. Not available in all areas.

**cellular carrier** One of multiple competing organizations in a given geographic area that owns and operates a cellular system.

**cellular signal** The radio waves that carry information between your cellular phone and the cellular system.

**cellular system** The cellular equipment in a given geographic area that relays signals to and from individual cellular telephones and the landline telephone system.

## D

**DTMF tones** See Dual Tone Multi-Frequency tones.

**default** A feature's original setting as pre-programmed in the factory.

**Dual Tone Multi-Frequency tones** The tones that your telephone transmits when you press a key on the keypad. These tones are used to access automated calling systems such as Voice Mail, paging services, banking-by-phone, etc. These tones are also heard by the party on the other line if you use the Scratchpad while a call is in progress. Synonymous with Scratchpad tones or touch tones.

## E

**emergency call** This feature allows you to make an emergency call even if your phone is locked, by dialing 911 or another emergency access number.

## F

**fringe area** The outermost range of a cellular system where signals are weak.

**function keys** The non-numeric keys on your phone's keypad used to perform specific tasks.

## H

**home system** The local cellular system where you obtain your cellular service.

**home type system** A cellular system of the same type as your local cellular system. See also non-home type system, and system type.

## I

**icon** One of the variety of symbols used to designate menu features and messages.

**indicator** A light on your phone that gives you information about your phone's status.

**Internal Charger** A charger built into your phone for use with an AC adapter or vehicle power adapter. See "Using the Internal Charger" on page 20.

## K

**Keypad Tones** The sounds produced through your phone's speaker when you press the keys. See "Turning Keypad Tones On and Off" on page 78.

## L

**landline** The telephone system used for conventional office and home phones.

**Lithium Ion** (Lilon) A battery technology used in personal cellular telephones.

**lock** Use this feature to prevent unauthorized access to your telephone.

**lock code** A three-digit code used to access your phone once it has been locked. The factory programmed lock code is 123. To view or change your lock code, see "Locking/Unlocking Your Phone" on page 83.

## M

**memory location** A space in the internal Phone Book where you can store a telephone number and a name.

**menu feature** Any feature that can be accessed through the menu system.

**menu system** The hierarchical arrangement of your phone's features that allows for quick, intuitive access. The top-level menu contains: Phone Book, Time and Date, Timers, Tone Control, Lock Secure, Phone Options, Network Selection, and Message Center.

**Message Center Key** Located on the bottom row of the keypad, the dedicated Message Center Key provides quick access to messages and messaging functions. See "Using the Message Center" on page 107.

## N

**name directory** An alphabetical list of the names and telephone numbers you have stored into your phone's internal Phone Book.

**network connection time** The elapsed time, in one-minute intervals, from the moment you connect to your Service Provider's network to the moment you end the call. The time includes busy signals and ringing.

## P

**pause** A special character that tells your phone to “pause” or wait for your input before sending a group of numbers stored in memory.

**Pause Dialing** A method of storing Phone Book entries that allows you to store multiple strings of numbers in one memory location; useful, for instance, in accessing automated phone systems. See “Storing and Placing Numbers with Pause Dialing” on page 53.

**Personal Identification Number (PIN)** A private numeric password that protects personal accounts such as bank-by-phone or Voice Mail.

**prompt** A message requesting input.

## R

**road map** The visual representation of your phone’s menu system provided in this user guide.

## S

**scratchpad tones** The tones that your telephone transmits when you press a key on the keypad. These tones are used to access automated calling systems such as Voice Mail, paging services, banking-by-phone, etc. These tones are also heard by the party on the other line if you use the Scratchpad while a call is in progress. Synonymous with Dual Tone Multi-Frequency tones.

**scroll** To move backward or forward through a list; for example: to move backward or forward through the menu system or the name directory.

**security code** A six-digit code used to access sensitive features in the Secure Options submenu of the Lock/Security menu.

**Service Provider** A company affiliated with a cellular carrier that provides satellite service to its customers.

**signal** The radio waves that carry information between your phone and the satellite system.

**Smart Button** The middle key on the side of your phone used to access the Phone Book’s name directory, send calls, end calls, enter the menu system, select features, and toggle features ON and OFF.

**Speed Dial** a feature that enables you to place a number by entering the two-digit location of your number and then pressing and holding the Smart Button.

**standby-time** The length of time a battery typically lasts if the phone is left ON but is not in use.

**status indicator** See indicator.

**submenu** A secondary level of your phone's menu system hierarchy.

**System Identification** A five-digit number that identifies your home cellular system. An even number indicates a wireline system and an odd number indicates a non-wireline system.

## T

**toggle** To switch between two possible options; for example: on versus off.

**Turbo Dial™ keys** a feature that enables you to dial numbers stored in memory locations by pressing and holding a single number key.

**TDMA (Time Division Multiple Access)** TDMA is an efficient method of providing digital cellular communication by allowing several different conversations on the same carrier frequency.

## V

**vehicle power adapter** An accessory device that allows you to power your phone and charge any attached batteries from a car's power adapter plug.

**VibraCall® alert** Motorola's silent vibration mode that discreetly alerts you to incoming calls.

**Voice Mail** Contact your Service Provider for availability.

**volume keys** Located on the side of your phone, the upper and lower volume keys are used to adjust phone volume.

# ***The U.S. Food and Drug Administration's Center for Devices and Radiological Health Consumer Update on Mobile Phones***



FDA has been receiving inquiries about the safety of mobile phones, including cellular phones and PCS phones. The following summarizes what is known—and what remains unknown—about whether these products can pose a hazard to health, and what can be done to minimize any potential risk. This information may be used to respond to questions.

## ***Why the concern?***

Mobile phones emit low levels of radio frequency energy (i.e., radio frequency radiation) in the microwave range while being used. They also emit very low levels of radio frequency energy (RF), considered non-significant, when in the stand-by mode. It is well known that high levels of RF can produce biological damage through heating effects (this is how your microwave oven is able to cook food). However, it is not known whether, to what extent, or through what mechanism, lower levels of RF might cause adverse health effects as well. Although some research has been done to address these questions, no clear picture of the biological effects of this type of radiation has emerged to date. Thus, the available science does not allow us to conclude that mobile phones are absolutely safe, or that they are unsafe. However, the available scientific evidence does not demonstrate any adverse health effects associated with the use of mobile phones.

## ***What kinds of phones are in question?***

Questions have been raised about hand-held mobile phones, the kind that have a built-in antenna that is positioned close to the user's head during normal telephone conversation. These types of mobile phones are of concern because of the short

distance between the phone's antenna—the primary source of the RF—and the person's head. The exposure to RF from mobile phones in which the antenna is located at greater distances from the user (on the outside of a car, for example) is drastically lower than that from hand-held phones, because a person's RF exposure decreases rapidly with distance from the source. The safety of so-called "cordless phones," which have a base unit connected to the telephone wiring in a house and which operate at far lower power levels and frequencies, has not been questioned.

### ***How much evidence is there that hand-held mobile phones might be harmful?***

Briefly, there is not enough evidence to know for sure, either way; however, research efforts are on-going. The existing scientific evidence is conflicting and many of the studies that have been done to date have suffered from flaws in their research methods. Animal experiments investigating the effects of RF exposures characteristic of mobile phones have yielded conflicting results. A few animal studies, however, have suggested that low levels of RF could accelerate the development of cancer in laboratory animals. In one study, mice genetically altered to be predisposed to developing one type of cancer developed more than twice as many such cancers when they were exposed to RF energy compared to controls. There is much uncertainty among scientists about whether results obtained from animal studies apply to the use of mobile phones. First, it is uncertain how to apply the results obtained in rats and mice to humans. Second, many of the studies that showed increased tumor development used animals that had already been treated with cancer-causing chemicals, and other studies exposed the animals to the RF virtually continuously—up to 22 hours per day.

For the past five years in the United States, the mobile phone industry has supported research into the safety of mobile phones. This research has



resulted in two findings in particular that merit additional study:

- 1.** In a hospital-based, case-control study, researchers looked for an association between mobile phone use and either glioma (a type of brain cancer) or acoustic neuroma (a benign tumor of the nerve sheath). No statistically significant association was found between mobile phone use and acoustic neuroma. There was also no association between mobile phone use and gliomas when all types of types of gliomas were considered together. It should be noted that the average length of mobile phone exposure in this study was less than three years.

When 20 types of glioma were considered separately, however, an association was found between mobile phone use and one rare type of glioma, neuroepitheliomatous tumors. It is possible with multiple comparisons of the same sample that this association occurred by chance. Moreover, the risk did not increase with how often the mobile phone was used, or the length of the calls. In fact, the risk actually decreased with cumulative hours of mobile phone use. Most cancer causing agents increase risk with increased exposure. An ongoing study of brain cancers by the National Cancer Institute is expected to bear on the accuracy and repeatability of these results.<sup>1</sup>

- 2.** Researchers conducted a large battery of laboratory tests to assess the effects of exposure to mobile phone RF on genetic material. These included tests for several kinds of abnormalities, including mutations, chromosomal aberrations, DNA strand breaks, and structural changes in the genetic material of blood cells called lymphocytes. None of the tests showed any effect of the RF except for the micronucleus assay, which detects structural effects on the genetic material. The cells in this assay showed

changes after exposure to simulated cell phone radiation, but only after 24 hours of exposure. It is possible that exposing the test cells to radiation for this long resulted in heating. Since this assay is known to be sensitive to heating, heat alone could have caused the abnormalities to occur. The data already in the literature on the response of the micronucleus assay to RF are conflicting. Thus, follow-up research is necessary.<sup>2</sup>

FDA is currently working with government, industry, and academic groups to ensure the proper follow-up to these industry-funded research findings. Collaboration with the Cellular Telecommunications Industry Association (CTIA) in particular is expected to lead to FDA providing research recommendations and scientific oversight of new CTIA-funded research based on such recommendations.

Two other studies of interest have been reported recently in the literature:

- 1.** Two groups of 18 people were exposed to simulated mobile phone signals under laboratory conditions while they performed cognitive function tests. There were no changes in the subjects' ability to recall words, numbers, or pictures, or in their spatial memory, but they were able to make choices more quickly in one visual test when they were exposed to simulated mobile phone signals. This was the only change noted among more than 20 variables compared.<sup>3</sup>
- 2.** In a study of 209 brain tumor cases and 425 matched controls, there was no increased risk of brain tumors associated with mobile phone use. When tumors did exist in certain locations, however, they were more likely to be on the side of the head where the mobile phone was used.

Because this occurred in only a small number of cases, the increased likelihood was too small to be statistically significant.<sup>4</sup>

In summary, we do not have enough information at this point to assure the public that there are, or are not, any low incident health problems associated with use of mobile phones. FDA continues to work with all parties, including other federal agencies and industry, to assure that research is undertaken to provide the necessary answers to the outstanding questions about the safety of mobile phones.

***What is known about cases of human cancer that have been reported in users of hand-held mobile phones?***

Some people who have used mobile phones have been diagnosed with brain cancer. But it is important to understand that this type of cancer also occurs among people who have not used mobile phones. In fact, brain cancer occurs in the U.S. population at a rate of about 6 new cases per 100,000 people each year. At that rate, assuming 80 million users of mobile phones (a number increasing at a rate of about 1 million per month), about 4800 cases of brain cancer would be expected each year among those 80 million people, whether or not they used their phones. Thus it is not possible to tell whether any individual's cancer arose because of the phone, or whether it would have happened anyway. A key question is whether the risk of getting a particular form of cancer is greater among people who use mobile phones than among the rest of the population. One way to answer that question is to compare the usage of mobile phones among people with brain cancer with the use of mobile phones among appropriately matched people without brain cancer. This is called a case-control study. The current case-control study of brain cancers by the National Cancer Institute, as well as the follow-up research to be sponsored by industry, will begin to generate this type of information.

## ***What is FDA's role concerning the safety of mobile phones?***

Under the law, FDA does not review the safety of radiation-emitting consumer products such as mobile phones before marketing, as it does with new drugs or medical devices. However, the agency has authority to take action if mobile phones are shown to emit radiation at a level that is hazardous to the user. In such a case, FDA could require the manufacturers of mobile phones to notify users of the health hazard and to repair, replace or recall the phones so that the hazard no longer exists.

Although the existing scientific data do not justify FDA regulatory actions at this time, FDA has urged the mobile phone industry to take a number of steps to assure public safety. The agency has recommended that the industry:

- support needed research into possible biological effects of RF of the type emitted by mobile phones
- design mobile phones in a way that minimizes any RF exposure to the user that is not necessary for device function
- cooperate in providing mobile phone users with the best possible information on what is known about possible effects of mobile phone use on human health

At the same time, FDA belongs to an interagency working group of the federal agencies that have responsibility for different aspects of mobile phone safety to ensure a coordinated effort at the federal level. These agencies are:

- National Institute for Occupational Safety and Health
- Environmental Protection Agency
- Federal Communications Commission
- Occupational Health and Safety Administration

- National Telecommunications and Information Administration

The National Institutes of Health also participates in this group.

***In the absence of conclusive information about any possible risk, what can concerned individuals do?***

If there is a risk from these products—and at this point we do not know that there is—it is probably very small. But if people are concerned about avoiding even potential risks, there are simple steps they can take to do so. For example, time is a key factor in how much exposure a person receives. Those persons who spend long periods of time on their hand-held mobile phones could consider holding lengthy conversations on conventional phones and reserving the hand-held models for shorter conversations or for situations when other types of phones are not available.

People who must conduct extended conversations in their cars every day could switch to a type of mobile phone that places more distance between their bodies and the source of the RF, since the exposure level drops off dramatically with distance. For example, they could switch to:

- a mobile phone in which the antenna is located outside the vehicle
- a hand-held phone with a built-in antenna connected to a different antenna mounted on the outside of the car or built into a separate package
- a headset with a remote antenna to a mobile phone carried at the waist

Again, the scientific data do not demonstrate that mobile phones are harmful. But if people are concerned about the radio frequency energy from these products, taking the simple precautions outlined above can reduce any possible risk.

## ***Where can I find additional information?***

For additional information, see the following websites:

**Federal Communications Commission (FCC)** RF Safety Program (select "Information on Human Exposure to RF Fields from Cellular and PCS Radio Transmitters"):

<http://www.fcc.gov/oet/rfsafety>

**World Health Organization (WHO)** International Commission on Non-Ionizing Radiation Protection (select Qs & As): <http://www.who.int/emf>

**United Kingdom, National Radiological Protection Board:** <http://www.nrpb.org.uk>

**Cellular Telecommunications Industry Association (CTIA):** <http://www.wow-com.com>

**U.S. Food and Drug Administration (FDA)** Center for Devices and Radiological Health:

<http://www.fda.gov/cdrh/consumer/>

1. Muscat et al. Epidemiological Study of Cellular Telephone Use and Malignant Brain Tumors. In: State of the Science Symposium; 1999 June 20; Long Beach, California.
2. Tice et al. Tests of mobile phone signals for activity in genotoxicity and other laboratory assays. In: Annual Meeting of the Environmental Mutagen Society; March 29, 1999, Washington, D.C.; and personal communication, unpublished results.
3. Preece, AW, Iwi, G, Davies-Smith, A, Wesnes, K, Butler, S, Lim, E, and Varey, A. Effect of a 915-MHz simulated mobile phone signal on cognitive function in man. *Int. J. Radiat. Biol.*, April 8, 1999.
4. Hardell, L, Nasman, A, Pahlson, A, Hallquist, A and Mild, KH. Use of cellular telephones and the risk for brain tumors: a case-control study. *Int. J. Oncol.*, 15: 113-116, 1999.

FDA020400

EXPORT LAW ASSURANCES: This product is controlled under the export regulations of the United States of America and Canada. The Governments of the United States of America and Canada may restrict the exportation or re-exportation of this product to certain destinations. For further information contact the U.S. Department of Commerce or the Canadian Department of Foreign Affairs and International Trade.

# Patent Information

---

Manufactured under one or more of the following U.S. patents:

4291475	4809356	5008925	5127040	5214774	5323421	5453997	5539360
4302845	4811377	5010309	5127042	5216389	5325405	5457744	5542016
4312074	4811404	5010570	5127100	5220290	5325429	5459640	5542103
4365221	4817157	5014294	5128834	5220936	5327578	5459774	5542106
4369516	4827507	5014346	5133010	5222078	5327642	5461643	5542116
4369520	4829543	5017856	5134717	5222104	5331123	5463351	5544250
4369522	4831647	5018188	5140286	5222251	5333153	5463406	5546275
4374370	4843621	5020076	5140635	5230007	5336984	5463628	5546380
4378603	4845772	5020091	5142551	5230093	5338909	5463646	5551078
4390963	4851966	5020092	5142696	5233506	5343213	5463674	5551627
4398265	4852090	5020093	5144533	5233633	5349588	5463688	5553137
4400584	4860336	5023580	5146620	5235492	5351245	5463694	5553376
4400585	4860341	5023866	5148471	5237257	5359696	5465409	5554996
4434461	4868576	5023911	5148473	5237570	5361400	5465412	5555550
4455534	4870686	5025387	5150075	5239127	5363071	5469177	5557743
4486624	4872196	5027388	5150359	5241545	5365549	5471671	5559471
4491972	4873683	5028083	5150384	5241548	5366826	5475752	5559522
4523155	4876552	5028859	5151643	5241592	5367538	5477192	5559806
4546329	4876656	5029233	5152006	5241688	5367558	5485506	5561436
4574243	4876740	5036532	5152007	5242767	5371791	5485513	5561437
4581602	4879533	5038253	5153590	5243355	5373101	5486843	5561852
4581749	4885553	5040127	5157693	5247544	5375143	5487184	5565881
4585957	4887050	5042071	5160898	5247565	5375258	5488649	5566224
4593155	4890199	5045824	5162144	5249302	5379324	5490177	5568548
4594657	4896124	5053924	5163159	5251331	5381114	5491739	5570453
4602218	4896361	5055800	5164652	5255292	5384825	5493198	5572223
4605987	4897873	5055802	5166596	5257414	5392000	5493700	5572224
4616314	4903326	5055803	5166642	5259005	5392023	5493714	5574976
4617520	4903327	5057762	5168522	5260170	5392331	5495206	5577267
4628529	4904549	5058136	5170173	5260988	5396654	5495208	5577268
4629829	4904992	5059885	5170485	5261119	5401927	5497126	5583520
4633141	4905288	5060264	5170492	5262710	5402447	5497382	5584054
4636593	4905301	5061340	5175729	5263052	5402448	5497383	5586146
4636741	4912602	5065408	5175759	5263055	5404580	5499273	5588041
4648125	4916262	5067139	5175874	5265271	5404582	5499394	5589796
4649543	4918431	5070310	5182749	5267230	5406146	5499397	5590177
4654655	4918732	5077757	5185566	5276588	5406562	5502437	5594778
4680787	4922178	5077790	5185790	5276707	5408693	5504494	5594951
4704588	4941203	5081674	5187640	5276913	5410275	5504812	5598129
4711361	4942570	5083304	5187809	5276915	5410741	5506490	5598431
4715063	4945570	5087004	5192924	5278832	5414711	5508709	5600341
4717884	4956854	5093632	5193223	5278994	5420759	5509048	5604050
4730195	4959851	5095503	5195106	5280630	5424689	5510693	5604468
4731813	4963812	5107487	5195108	5280637	5428362	5511235	5604787
4736277	4964121	5109400	5198887	5280644	5428820	5513078	5606332
4737976	4970475	5111162	5200655	5285443	5428836	5513996	5606560
4741018	4972355	5113400	5201069	5287013	5430416	5519303	5606730
4742562	4972432	5113436	5203009	5287553	5432017	5519346	5613229
4761621	4972455	5117073	5203012	5287555	5434947	5519506	5613863
4764737	4975808	5117441	5203013	5287556	5436802	5519777	5615233
4775998	4977589	5117449	5203021	5289505	5438684	5524276	5615259
4791527	4977616	5117450	5204977	5297142	5442680	5526398	5615260
4794489	4979207	5121047	5205751	5299232	5444764	5528666	5621763
4797929	4984219	5121288	5210793	5301365	5446763	5530399	5621766
4797947	4984290	5121412	5211581	5308716	5446766	5530922	5625316
4798975	4989230	5122480	5212815	5321705	5448763	5533119	5625683
4802236	4992753	5122722	5212826	5321737	5448770	5535258	5628001
4803726	4996529	5124889	5214675	5321847	5448771	5535434	5628057



5628089	5737685	5826224	5912648	6014376	D328302	D353591	D381664
5629979	5738954	5831826	5920549	6014552	D332261	D354055	D382537
5630159	5739792	5832080	5920550	6016312	D332785	D354062	D382538
5630210	5740525	5832388	5923007	6016422	D334746	D355181	D382272
5630213	5742894	5835006	5924044	6018584	D337332	D355895	D383115
5630215	5745116	5835535	5925835	6018651	D338012	D356084	D383748
5631538	5745566	5835785	5925942	6018671	D338887	D356309	D383749
5633484	5745848	5838202	5926119	6021332	D339127	D357224	D383759
5633786	5747970	5841851	5926503	D284759	D339335	D357249	D384080
5634202	5748727	5842122	5926751	D285439	D339336	D357457	D384662
5640690	5754141	5844943	5930268	D288432	D339337	D357680	D384951
5642368	5754455	5846094	5930288	D288683	D339564	D357681	D384952
5646576	5754583	5848072	5930299	D289156	D339578	D358148	D385271
5649306	5754645	5848152	5933330	D292578	D339581	D359052	D385283
5649309	5754956	5848356	5936516	D292920	D339582	D359734	D385555
5656914	5758271	5848718	5936972	D295627	D340709	D359735	D385583
5656917	5760714	5850440	5939939	D295973	D340710	D359959	D385874
5657418	5761300	5854549	5940452	D295975	D340711	D360398	D385875
5659601	5761610	5854785	5940746	D296187	D340906	D360632	D385877
5660945	5764100	5854972	5943027	D297734	D341589	D361070	D385888
5661433	5764111	5856763	5945852	D297735	D342248	D361763	D386175
5664973	5764730	5856766	5945964	D297736	D342663	D362840	D386494
5666429	5764743	5857148	5946395	D299136	D342729	D362852	D386757
5668871	5766794	5857192	5949020	D299137	D342730	D365094	D387054
5670912	5771182	5859522	5950131	D299232	D342741	D365817	D387055
5673001	5771471	5859567	5950139	D300742	D343173	D366872	D387199
5673003	5777521	5859890	5953413	D300827	D343615	D367640	D387346
5673287	5777856	5861853	5954817	D301473	D343616	D368479	D388078
5674326	5784366	5862460	5955700	D301476	D343834	D368696	D388079
5675591	5784419	5862493	5955999	D301883	D343835	D369162	D388080
5675702	5784585	5864799	5956626	D302015	D343836	D369359	D388081
5678201	5787128	5865487	5963848	D303656	D344087	D369797	D388082
5678221	5787577	5867063	5963876	D304189	D344271	D370016	D388424
5678227	5793315	5867127	5964858	D305427	D344444	D370463	D388429
5680063	5793866	5867140	5966101	D305717	D344511	D370672	D388430
5684384	5796822	5867510	5966667	D306015	D344512	D372237	D388775
5691947	5797101	5870670	5966671	D306163	D344945	D372481	D388783
5692046	5798716	5872744	5969545	D306293	D345977	D372703	D388793
5692101	5799011	5877633	5974042	D306299	D346785	D372896	D389157
5696497	5799256	5878075	5977916	D306441	D346786	D372919	D389476
5696821	5801513	5878209	5980268	D306583	D346798	D373585	D389478
5699070	5801567	5878336	5982881	D306594	D348071	D373764	D389488
5699389	5802111	5878353	5983082	D307271	D348250	D374013	D389641
5699408	5805992	5880637	5987012	D309301	D348427	D374014	D390221
5701130	5807012	5880646	5988577	D309451	D348470	D374227	D390222
5701244	5808585	5881377	5995050	D314173	D348665	D374424	D390509
5701589	5808586	5889737	5996178	D315330	D348666	D374872	D391567
5703470	5809020	5889768	5999115	D315346	D348668	D375732	D391955
5703539	5809419	5889859	5999821	D315543	D348674	D375733	D391966
5703909	5809421	5892410	5999832	D315559	D348880	D375734	D393470
5706019	5809430	5893036	6002922	D315565	D349273	D375932	D394256
5706313	5809433	5894597	6002937	D315907	D349701	D375935	D394423
5708445	5809544	5896054	6005498	D316417	D350113	D375952	D394425
5710862	5812093	5896261	6006104	D316859	D350348	D376127	D394433
5710987	5812542	5898933	6008636	D320780	D350349	D377792	D394438
5711001	5812590	5900829	6009168	D322783	D350350	D377934	D394439
5711520	5814798	5901347	6009309	D324024	D351375	D378366	D395301
5715524	5815507	5901357	6009325	D324388	D351840	D378911	D395302
5717307	5815570	5903825	6009336	D325028	D352497	D379558	D395431
5722052	5815804	5903852	6009552	D325029	D352503	D379624	D395442
5724004	5815805	5905956	6011699	D325032	D352946	D379981	D395875
5726983	5815807	5907418	6011784	D325583	D353131	D379982	D396472
5729221	5815820	5907615	6011959	D325915	D353361	D380468	D397337
5732350	5821820	5909102	6011961	D327061	D353587	D380751	D397689
5737327	5822726	5910944	6012634	D327062	D353588	D381021	D397694

D398926	D400527	D405782	D407063	D408815	D411202	D412487	D416226
D400161	D400874	D405801	D407685	D409186	D411204	D412709	D417224
D400165	D401554	D406098	D407708	D410459	D411507	D413893	D417449
D400204	D401929	D406191	D408401	D410460	D411535	D413898	D419155
D400209	D403265	D406586	D408402	D410929	D411843	D414159	D419290
D400496	D404397	D406695	D408418	D411165	D411844	D415122	D419565
D400526	D405080	D406812	D408783	D411196	D412000	D415499	PAT022500

Other patents pending.

# Index

---

## A

- access number for voice mail
  - 132
- accessories 133, 133–135
  - batteries 133
  - desktop charger 134
  - hands-free kit 135
  - headset 134
  - holster 134
  - vehicle power adapter 133
- accessory connector port 12
- analog mode 30
- antenna 12
- audible timer
  - one-minute 71
  - repeating 72
- automatic answer 98
- automatic hands-free 96
- autoupdate 66
- auxiliary battery
  - installing 18
  - removing 19

## B

- battery
  - accessories 133
  - auxiliary
    - installing 18
    - removing 19
  - charge times 21
  - charging 20
    - desktop charger 21
    - internal charger 20
    - tips 22
    - two batteries at once 21
  - checking levels 19
  - cover
    - attachment 16
    - removal 16
  - desktop charging 21

- disposal 15
  - installing 18
  - life 136
  - low battery warning 19
  - main
    - installing 18
    - removing 18
  - overview 15
  - power save mode 99
  - removing 18
  - slim auxiliary 11
  - slim main 11
  - standard main 11
  - storage 15
  - types 15
- battery cover
    - auxiliary
      - attaching 17
      - removing 17
    - main
      - attaching 16
      - removing 16
  - battery level
    - checking 19
    - indicator 19, 25
    - messages 20
  - Battery Level Indicator 25
  - busy signal 137
  - button
    - Message 12
    - Smart 12

## C

- call
  - ending 29
  - placing 28
    - calling card call 56
    - restricting call placement 86
  - receiving 29
    - open to answer 97

- while phone is locked 84
- Call Back number 118
- Call Mode
  - selecting preferred 93
- call timer
  - automatically display 71
  - cumulative 70
  - individual 69
  - resettable 70
  - resetting 70
- call waiting 45
- Caller ID 48
- Caller Line ID 44, 45
- calling card
  - PIN number 56
  - placing calling card call 56
  - storing information 55, 137
- calls
  - dialed 47
  - managing recent 43
  - received 46
- changing your number 94
- charge times, battery 21
- chargers
  - desktop charger 134
  - internal 20
- charging batteries 20
- clearing a memory entry 39
- clock, setting 64
- connector port 12
- cumulative timer 70

## **D**

- date
  - changing format 65
  - setting 65
- desktop charger 11, 21, 134
- dialed calls 47
- digital
  - indicator 23, 24
  - mode 30
- display
  - System Identification 99

## **E**

- earpiece 12
- ending a call 29

## **F**

- feature review 95
- function keys 12

## **G**

- glossary 138–142

## **H**

- hands-free
  - automatic 96
  - kit 135
  - operation 135
- headset 11, 134
- headset jack 12
- holster 11, 27, 134
- home system 95

## **I**

- In Use Indicator 24
- In-Building Indicator 24
- indicator
  - Battery Level 25
  - Digital 24
  - In Use 24
  - In-Building 24
  - No Service 24
  - Power/Status 26
  - reading 24
  - Signal Strength 24
  - SMS message waiting 25
  - Voice Message Waiting 25

## **J**

- jack, headset 12

## **K**

- key answer, multiple 97
- key presses 14

keypad tones 78

## L

language, select for display 100

lock code

changing 85

viewing 85

locking phone

answering calls while phone is  
locked 84

automatically 83

manually 83

locking/unlocking phone 83

## M

main battery

installing 18

removing 18

Master Clear 89

Master Reset 88

memory location

editing 58

service level 86

using phone book 34

menus

entering 28

navigating 42

message

clearing 118

draft messages 125

forwarding messages 114

Outbox

forwarding a message 129

resending a message 128

viewing message details  
130

outbox messages 126

Quick Notes

creating 123

deleting 124

sending 122

quick notes 122

reading messages 111

replying to messages 113

sending messages 119

unlocking 117

viewing message details 115

message alert 110

Message Center button 12

messages, locking 117

microphone 12

Multiple Key Answer 97

## N

network connection time 69

network selection 101

automatic search 106

listing non-public network 106

manual search 103

non-public 103

public network 105

search for new network 104

No Service Indicator 24

non-public network

listing 106

## O

open to answer 97

option

clearing stored information 89

reset 88

Outbox

forwarding a message 129

resending a message 128

viewing message details 130

## P

package contents 11

Pager Mode 92, 97

pager mode 76

pause dialing 54

pauses

entering into a number 53

placing a call with pauses 54

phone book

clearing entry 39

editing entries 58

- entering letters 36
- entering text 36
- entry
  - attaching email address 57, 60
  - recalling by location 51
  - recalling by name 51
  - recalling with short cuts 39
- recalling entry
  - by location 38
  - by name 38
- storing entry 52
- storing names and numbers
  - 34
  - using 34
- phone number, viewing your own
  - 23, 94
- phone overview 12
- PIN number 56
- placing a call 28
- power button 12, 136
- power save mode 99
- power sources, switching 22
- power status messages 20
- Power/Status Indicator 26
- Priority Call 39
- prompts, defined 14
- public network 105

## Q

- Quick Notes 122
  - creating 123
  - deleting 124
  - sending 122

## R

- recalling entry by location 38
- recalling entry by name 38
- received calls 46
- receiving call
  - automatic answer 98
  - multiple key answer 97
  - procedure 29
- Recent Calls menu 44

- redialing a number 30
- retractable antenna 12
- ringer
  - selecting style 78
  - suppressing 29
  - vibrating 61, 76, 78
- road map 42
  - call timers 68
  - lock security 81
  - phone book 50
- recent calls 44
- tone controls 75

## S

- scratchpad tones 40, 79, 137
- Seamless Connection 22
- security options
  - resetting 88
  - service level 86
- Short Message Service
  - clearing message 118
  - draft messages 125
  - forwarding a message 114
  - indicator 25
  - locking message 117
  - outbox messages 126
  - quick notes 122
  - reading messages 111
  - replying to messages 113, 128
  - sending messages 119
  - unlocking a message 117
  - viewing message details 115
- Short Messaging Services (SMS) 110
- Signal Strength Indicator 24
- single timer 73
- Smart Button 27
- smart button 12
- SMS Message Waiting Indicator 25
- Speed Dial 39
- standby mode 27
- storing
  - calling card information 55

- names and numbers 34
- storing names and numbers 52
- System Identification
- viewing 99

## T

- time
  - changing format 66
- time, setting 64
- timer
  - audible one-minute 71
  - audible repeating 72
  - automatically display individual timer 71
  - cumulative call timer 70
  - individual call timer 69
  - one-minute audible 71
  - repeating audible timer 72
  - reset 70
  - resettable call timer 70
  - single 73
- tips, defined 14
- tones
  - alternating high/low 137
  - call alert 76
  - turning scratchpad tones on and off 79
- Turbo Dial® 34, 39
- turning phone off 23
- turning phone on 23

## U

- unanswered call indicator 29
- unlock phone 136

## V

- vehicle power adapter 11, 133
- VibraCall® Alert 25, 32, 61, 76, 77, 78
- vibrating ringer 61, 76, 78
- voice mail 25, 77, 137
  - dialing 109
  - edit access number 132

- Voice Message Waiting Indicator 25
- voice privacy 82
- volume
  - adjusting 31
  - muting 31
  - silent vibration mode 32
- volume keys 12